



INSTYTUT TECHNIKI BUDOWLANEJ
PL 00-611 WARSZAWA
ul. Filtrowa 1
tel.: (+48 22) 825-04-71
(+48 22) 825-76-55
fax: (+48 22) 825-52-86
www.itb.pl



Member of



www.eota.eu

European Technical Assessment

**ETA-12/0398
of 30/06/2020**

General Part

Technical Assessment Body issuing the European Technical Assessment

Instytut Techniki Budowlanej

Trade name of the construction product

FF1

Product family to which the construction product belongs

Plastic anchors for multiple use in concrete and masonry for non-structural applications

Manufacturer

RAWLPLUG S.A.
ul. Kwidzyńska 6
PL 51-416 Wrocław
Poland

Manufacturing plant

Plant no. 2

This European Technical Assessment contains

30 pages including 3 Annexes which form an integral part of this Assessment

This European Technical Assessment is issued in accordance with regulation (EU) No 305/2011, on the basis of

Guideline for European Technical Approval of "Plastic anchors for multiple use in concrete and masonry for non-structural applications", ETAG 020, Edition March 2012 used as European Assessment Document (EAD)

This version replaces

ETA-12/0398 issued on 29/12/2017

This European Technical Assessment is issued by the Technical Assessment Body in its official language. Translations of this European Technical Assessment in other languages shall fully correspond to the original issued document and shall be identified as such.

Communication of this European Technical Assessment, including transmission by electronic means, shall be in full. However, partial reproduction may only be made with the written consent of the issuing Technical Assessment Body. Any partial reproduction has to be identified as such.

Specific Part

1 Technical description of the product

The FF1 anchors consists of a plastic sleeve made of polypropylene (FF1 PP) or polyamide (FF1 PA) and an accompanying specific screw made of steel with electroplated zinc coating, steel with zinc flake coating or stainless steel.

The plastic sleeve is expanded by screwing in the specific screw which presses the sleeve against the wall of the drilled or punched hole.

The description of the product are given in Annex A.

2 Specification of the intended use in accordance with the applicable European Assessment Document (EAD)

The performance given in Annex C are only valid if the anchor is used in compliance with the specifications and conditions given in Annex B.

The provisions made in this European Technical Assessment are based on an assumed working life of the anchor of 50 years. The indications given on the working life cannot be interpreted as a guarantee given by the producer or Technical Assessment Body, but are to be regarded only as a means for choosing the right products in relation to the expected economically reasonable working life of the works.

3 Performance of the product and references to the methods used for its assessment

3.1. Performance of the product

3.1.1. Mechanical resistance and stability (BWR 1)

Requirements with respect to the mechanical resistance and stability of non load bearing parts of the works are not included in this Basic Requirement but are under the Basic Requirement safety and accessibility in use (BWR 4).

3.1.2. Safety in case of fire (BWR 2)

Essential characteristic	Performance
Reaction to fire	Anchorage satisfy requirements for Class A1
Resistance to fire	See Annex C2

3.1.3. Hygiene, health and the environment (BWR 3)

No performance assessed.

3.1.4. Safety and accessibility in use (BWR 4)

Essential characteristic	Performance
Characteristic resistance for tension and shear loads	Annex C1, C2, C3
Characteristic resistance for bending moment	Annex C1
Displacements under shear and tension loads	Annex C2, C4
Edge distances and spacings	Annex B3, B4

3.1.5. Sustainable use of natural resources (BWR 7)

No performance assessed.

3.1.6. General aspects relating to fitness for use

Durability and serviceability are only ensured if the specifications of intended use according to Annex B1 are kept.

3.2. Methods used for the assessment

The assessment of the products has been made in accordance with the ETAG 020 "Plastic anchors for multiple use in concrete and masonry for non-structural applications".

4 Assessment and verification of constancy of performance (AVCP) system applied, with reference to its legal base

According to the Decision 97/463/EC of the European Commission the system 2+ of assessment and verification of constancy of performance applies (see Annex V to Regulation (EU)).

5 Technical details necessary for the implementation of the AVCP system, as provided in the applicable European Assessment Document (EAD)

Technical details necessary for the implementation of the AVCP system are laid down in the control plan deposited in Instytut Techniki Budowlanej.

For the type testing the results of the tests performed as part of the assessment for the European Technical Assessment shall be used unless there are changes in the production line or plant. In such cases the necessary type testing has to be agreed between Instytut Techniki Budowlanej and the notified body.

Issued in Warsaw on 30/06/2020 by Instytut Techniki Budowlanej



Anna Panek, MSc
Deputy Director of ITB

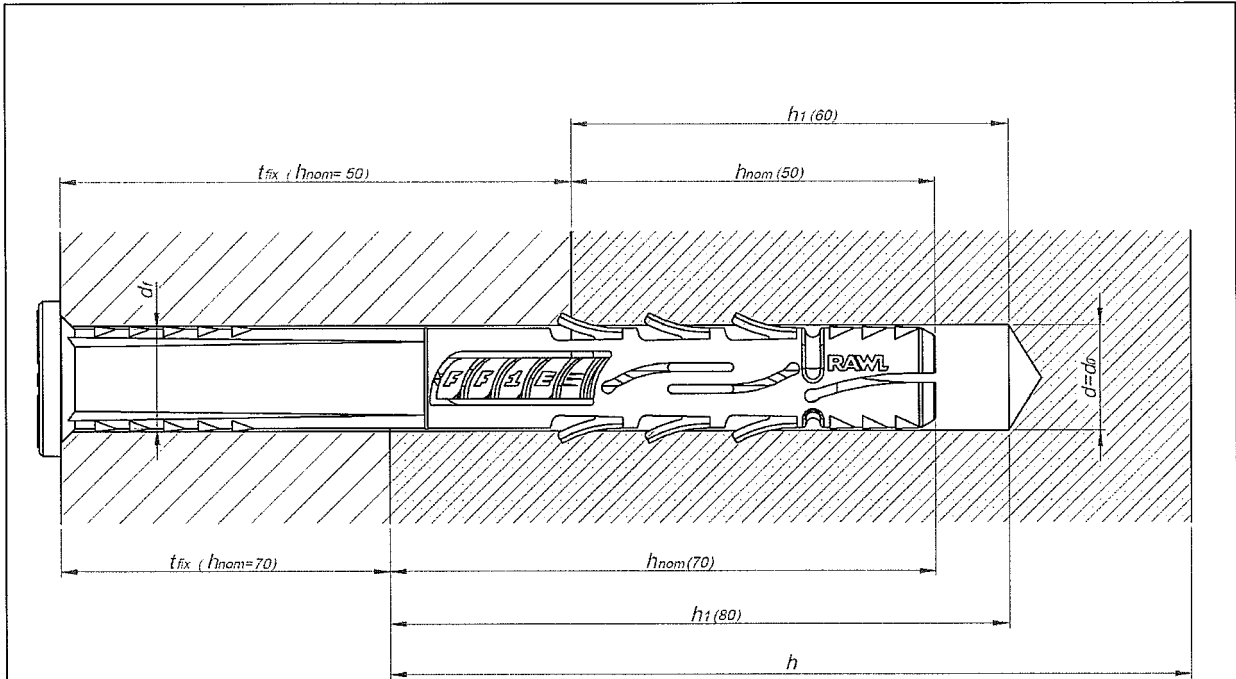

Intended Use

Fixing in concrete and different kinds of masonry

Legend

Numbers in brackets in picture above (XX) indicates overall plastic anchor embedment depth ($h_{nom} = 50$ or $h_{nom} = 70$ mm); for details see Table B2

- d_o = sleeve diameter (drill hole diameter)
- h_{nom} = overall plastic anchor embedment depth in the base material
- h_1 = depth of drill hole to deepest point
- h = thickness of member (wall)
- t_{fix} = thickness of fixture
- d_f = diameter of clearance hole in the fixture

FF1	Annex A1 of European Technical Assessment ETA-12/0398
Product description FF1-10K / FF1-14K	

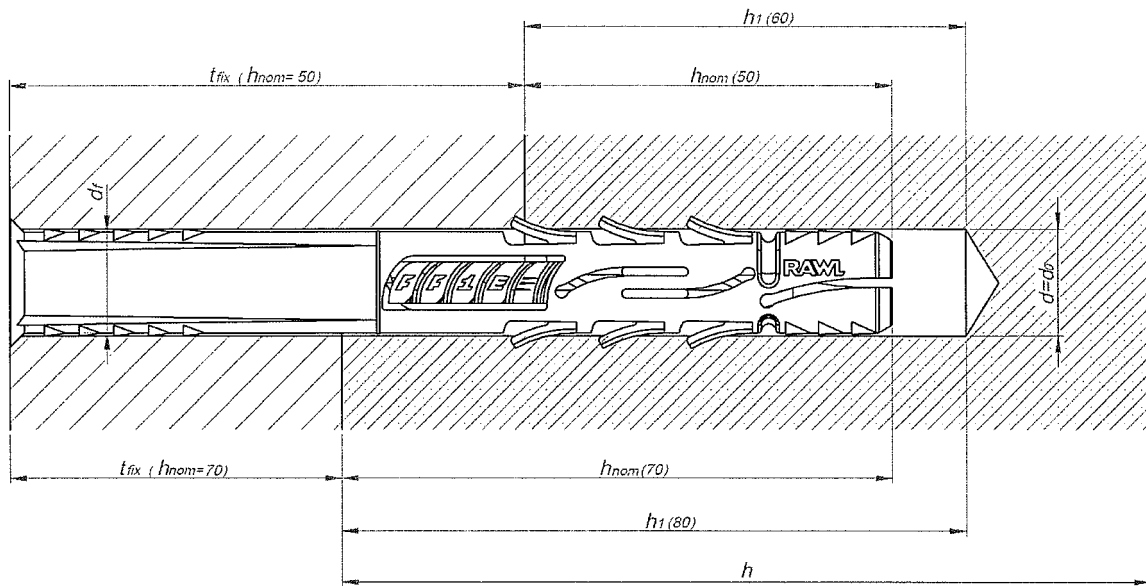

Intended Use

Fixing in concrete and different kinds of masonry

Legend

Numbers in brackets in picture above (XX) indicates overall plastic anchor embedment depth ($h_{nom} = 50$ or $h_{nom} = 70$ mm); for details see Table B2

- d_0 = sleeve diameter (drill hole diameter)
- h_{nom} = overall plastic anchor embedment depth in the base material
- h_1 = depth of drill hole to deepest point
- h = thickness of member (wall)
- t_{fix} = thickness of fixture
- d_f = diameter of clearance hole in the fixture

FF1	Annex A2 of European Technical Assessment ETA-12/0398
Product description FF1-08L / FF1-10L / FF1-14L	

FF1-08L plastic sleeve

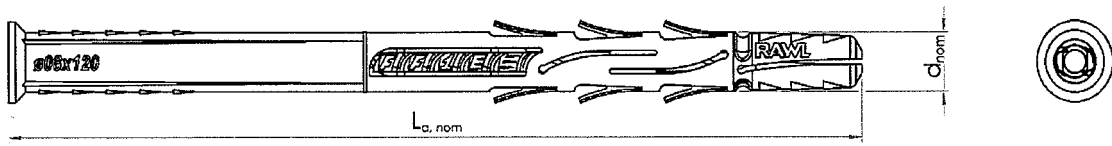

FF1-10K plastic sleeve

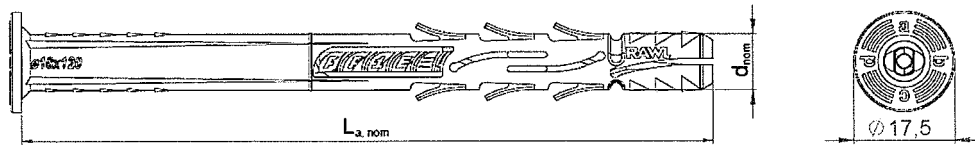

FF1-10L plastic sleeve

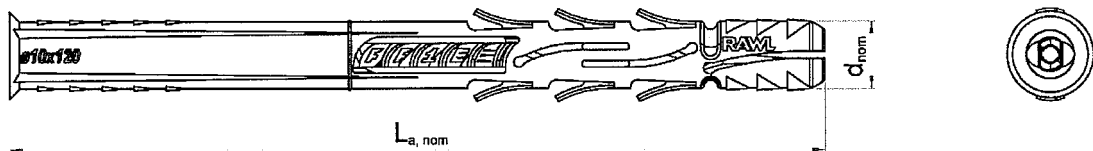

FF1-14K plastic sleeve

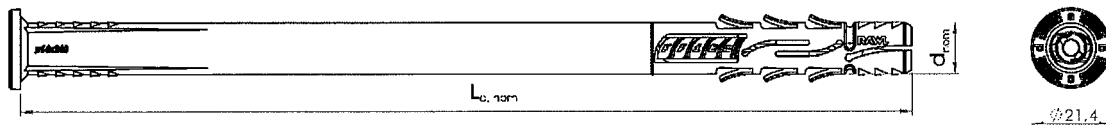

FF1-14L plastic sleeve

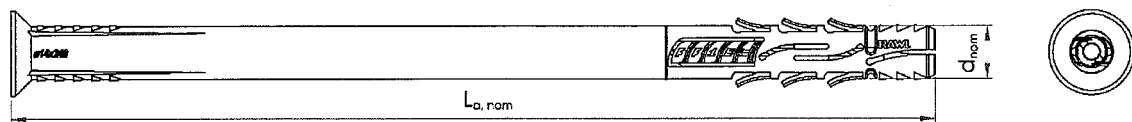

Pre-assembled FF1 anchor

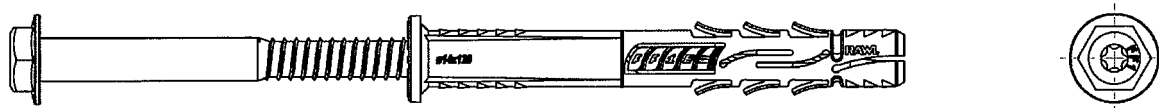

FF1	Annex A3
Product description Plastic sleeves of FF1 anchors	of European Technical Assessment ETA-12/0398

FF1-08L steel screw

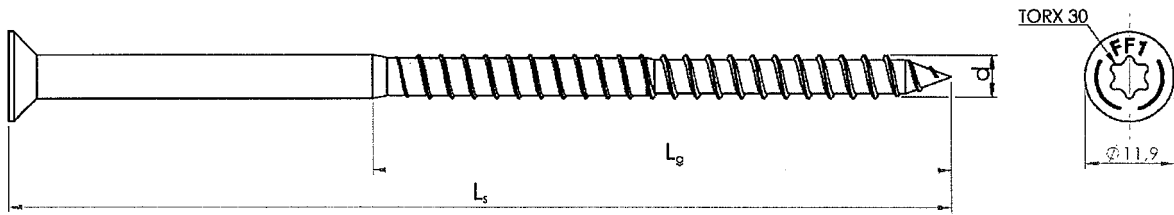

FF1-10K steel screws

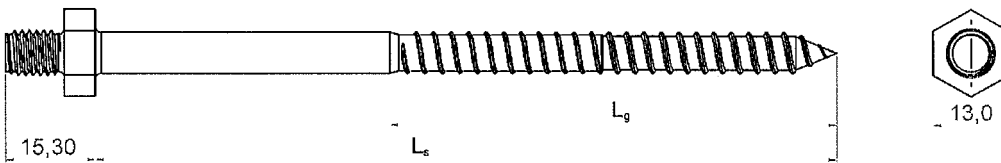
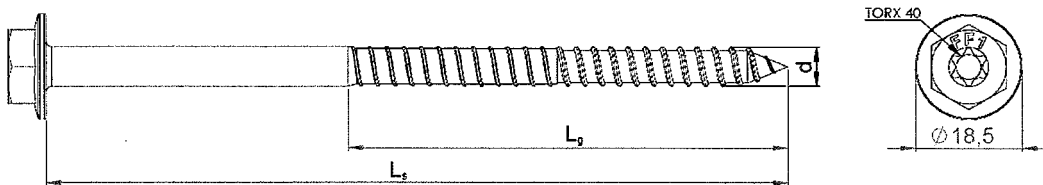

FF1-10L steel screw

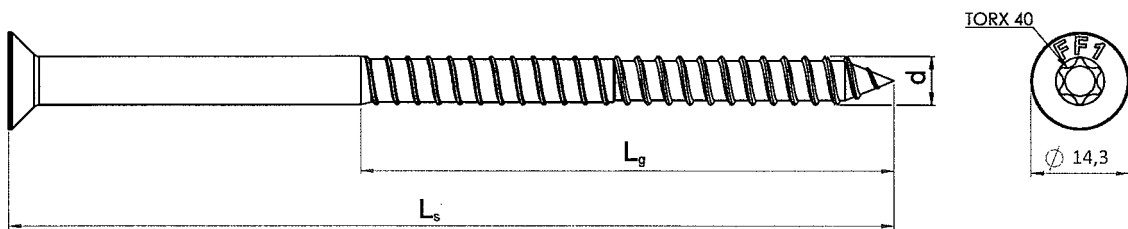

FF1-14K steel screw

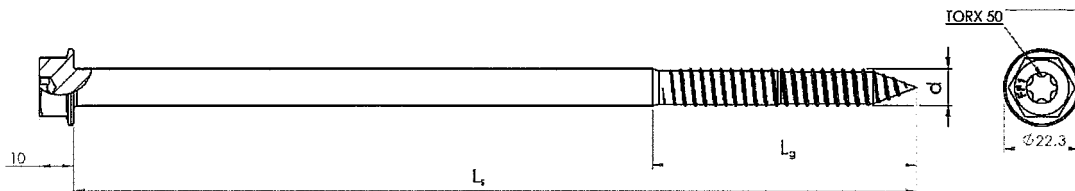

FF1-14L steel screw

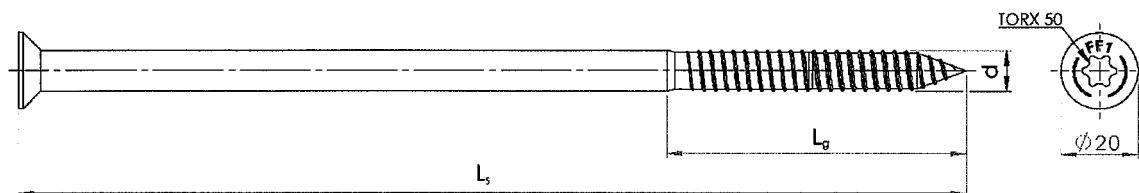

FF1	Annex A4 of European Technical Assessment ETA-12/0398
Product description Steel screws of FF1 anchors	

Marking

Size of the anchor and material

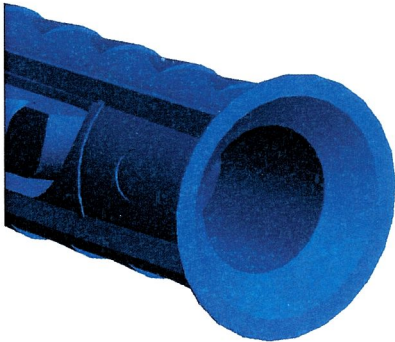

a) polyamide (PA): blue without dot

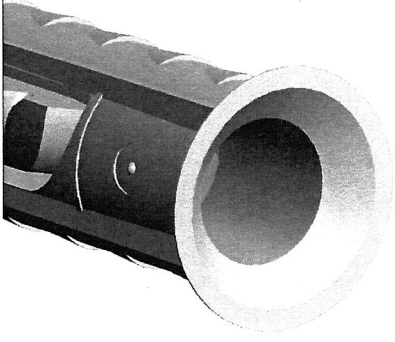
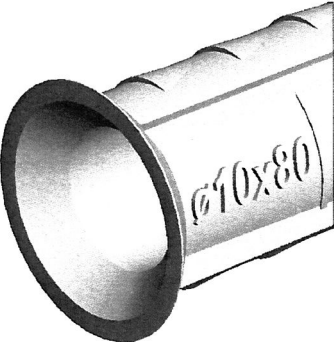

b) polypropylene (PP): grey marked with dot

<p>FF1</p>	<p>Annex A5 of European Technical Assessment ETA-12/0398</p>
<p>Product description Anchor sleeve marking</p>	

Table A1: Anchor types and dimensions [mm]

Anchor type	Anchor sleeve ¹⁾		Screw ¹⁾		
	d _{nom} [mm]	l _{a, nom} [mm]	l _{s, min} [mm]	l _{g, min} [mm]	d _s [mm]
FF1-08L					
FF1-08L	7,8 _{±0,2}	80 _{±1,0}	87 _{±1,0}	76 _{±1}	5,8 _{-0,2}
FF1-08L	7,8 _{±0,2}	100 _{±1,0}	107 _{±1,0}	76 _{±1}	5,8 _{-0,2}
FF1-08L	7,8 _{±0,2}	120 _{±1,0}	127 _{±1,0}	76 _{±1}	5,8 _{-0,2}
FF1-08L	7,8 _{±0,2}	140 _{±1,0}	147 _{±1,0}	76 _{±1}	5,8 _{-0,2}
FF1-08L	7,8 _{±0,2}	160 _{±1,0}	167 _{±1,0}	76 _{±1}	5,8 _{-0,2}
FF1-10L					
FF1-10L	9,8 _{±0,2}	80 _{±2,0}	87 _{±1,0}	75 _{±1}	7,0 _{-0,2}
FF1-10L	9,8 _{±0,2}	100 _{±2,0}	107 _{±1,0}	75 _{±1}	7,0 _{-0,2}
FF1-10L	9,8 _{±0,2}	120 _{±2,0}	127 _{±1,0}	75 _{±1}	7,0 _{-0,2}
FF1-10L	9,8 _{±0,2}	140 _{±2,0}	147 _{±1,0}	75 _{±1}	7,0 _{-0,2}
FF1-10L	9,8 _{±0,2}	160 _{±2,0}	167 _{±1,0}	75 _{±1}	7,0 _{-0,2}
FF1-10L	9,8 _{±0,2}	200 _{±2,0}	207 _{±1,5}	75 _{±1,5}	7,0 _{-0,2}
FF1-10L	9,8 _{±0,2}	240 _{±2,0}	247 _{±1,5}	75 _{±1,5}	7,0 _{-0,2}
FF1-10L	9,8 _{±0,2}	300 _{±2,0}	307 _{±1,5}	75 _{±1,5}	7,0 _{-0,2}
FF1-14L					
FF1-14L	13,8 _{±0,2}	120 _{±1,0}	127 _{±1,0}	76 _{±1}	10,8 _{-0,2}
FF1-14L	13,8 _{±0,2}	160 _{±1,0}	167 _{±1,0}	76 _{±1}	10,8 _{-0,2}
FF1-14L	13,8 _{±0,2}	200 _{±1,0}	207 _{±1,0}	76 _{±1}	10,8 _{-0,2}
FF1-14L	13,8 _{±0,2}	240 _{±1,0}	247 _{±1,0}	76 _{±1}	10,8 _{-0,2}
FF1-10K					
FF1-10K	9,8 _{±0,2}	80 _{±3,0}	89 _{±1,0}	75 _{±1}	7,0 _{-0,2}
FF1-10K	9,8 _{±0,2}	100 _{±3,0}	109 _{±1,0}	75 _{±1}	7,0 _{-0,2}
FF1-10K	9,8 _{±0,2}	120 _{±3,0}	129 _{±1,0}	75 _{±1}	7,0 _{-0,2}
FF1-10K	9,8 _{±0,2}	140 _{±3,0}	149 _{±1,0}	75 _{±1}	7,0 _{-0,2}
FF1-10K	9,8 _{±0,2}	160 _{±3,0}	169 _{±1,0}	75 _{±1}	7,0 _{-0,2}
FF1-10K	9,8 _{±0,2}	200 _{±3,0}	209 _{±1,5}	75 _{±1,5}	7,0 _{-0,2}
FF1-10K	9,8 _{±0,2}	240 _{±3,0}	249 _{±1,5}	75 _{±1,5}	7,0 _{-0,2}
FF1-10K	9,8 _{±0,2}	300 _{±3,0}	309 _{±1,5}	75 _{±1,5}	7,0 _{-0,2}
FF1-14K					
FF1-14K	13,8 _{±0,2}	120 _{±1,0}	131 _{±1,0}	76 _{±1}	10,8 _{-0,2}
FF1-14K	13,8 _{±0,2}	160 _{±1,0}	171 _{±1,0}	76 _{±1}	10,8 _{-0,2}
FF1-14K	13,8 _{±0,2}	200 _{±1,0}	211 _{±1,0}	76 _{±1}	10,8 _{-0,2}
FF1-14K	13,8 _{±0,2}	240 _{±1,0}	251 _{±1,0}	76 _{±1}	10,8 _{-0,2}
¹⁾ The anchor (plastic sleeve and specific screw) shall only be packaged and supplied as a complete unit					

FF1	Annex A6 of European Technical Assessment ETA-12/0398
Product description Anchor types and dimensions	

Table A2: Materials

Element	Material	
	FF1 PP	FF1 PA
Anchor sleeve	Polypropylene, PP colour grey	Polyamide, PA6 colour blue
Specific screw	Carbon steel acc. to EN-ISO 898: - basic type a (with "•" on the head marking): $f_{y,k} \geq 260$ MPa, $f_{u,k} \geq 420$ MPa - basic type b: $f_{y,k} \geq 420$ MPa, $f_{u,k} \geq 580$ MPa - high load (with "H" on the head marking): $f_{y,k} \geq 640$ MPa, $f_{u,k} \geq 800$ MPa with: a) electroplated zinc coating ≥ 5 μm acc. to EN ISO 4042 or b) zinc flake coating acc. to EN ISO 10683 (≥ 36 g/m ²)	
	Stainless steel acc. to ISO 3506-1: $f_{y,k} \geq 420$ MPa, $f_{u,k} \geq 600$ MPa	

FF1

Product description
Materials

Annex A7

of European
Technical Assessment
ETA-12/0398

Punch tool

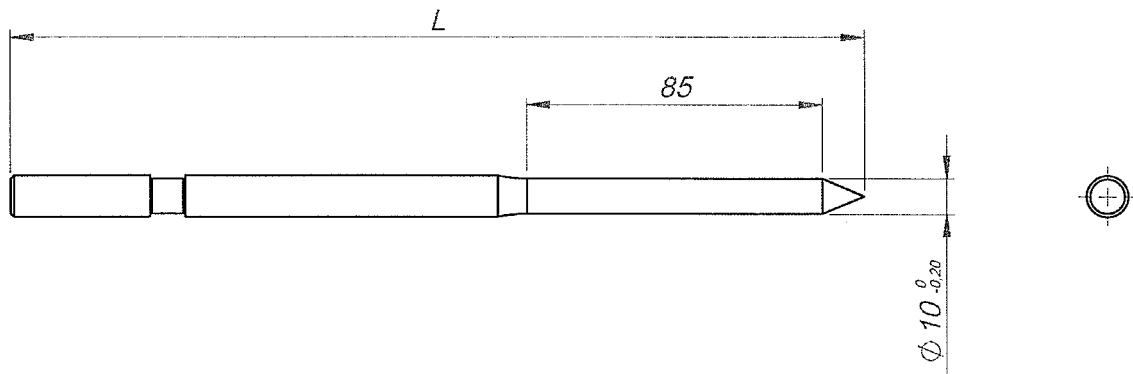

Used for variant installation of FF1-10 PA ($h_{nom} = 70$ mm) in AAC

FF1	Annex A8
Product description Punch tool for variant installation in AAC	of European Technical Assessment ETA-12/0398

Specification of intended use

Anchorage subject to:

- Static and quasi-static loads.
- Multiple fixing of non-structural applications.

Base materials:

- Reinforced or unreinforced normal weight concrete with strength classes \geq C12/15 (use category a), according to EN 206.
- Solid masonry (use category b), according to Annex C3.
Note: The characteristic resistance is also valid for larger sizes and larger compressive strength of the masonry unit.
- Hollow or perforated masonry (use category c), according to Annex C3.
- Autoclaved aerated concrete (use category d), according to Annex C3.
- Mortar strength class of the masonry M2,5 at minimum according to EN 998-2.
- For other base materials of the use categories a, b, c and d the characteristic resistance of the anchor may be determined by job site tests according to ETAG 020, edition March 2012, Annex B.

Temperature range:

- -20°C to +40°C (max. short term temperature +40°C and max. long term temperature +24°C) for FF1 PP anchors and FF1 10 PA anchors used in autoclaved aerated concrete.
- -40°C to +80°C (max. short term temperature +80°C and max. long term temperature +50°C) for FF1 PA anchors, except of FF1 10 PA anchors used in autoclaved aerated concrete.

Use conditions (environmental conditions):

- Structures subject to dry internal conditions (zinc coated steel, zinc flake coated steel or stainless steel).
- The specific screw made of zinc coated or zinc flake coated steel may also be used in structures subject to external atmospheric exposure if the area of the head of the screw is protected against moisture and driving rain after mounting of the fixing unit in this way, that intrusion of moisture into the anchor shaft is prevented. Therefore there shall be an external cladding or a ventilated rain screen mounted in front of the head of the screw and the head of the screw itself shall be coated with a soft plastic, permanently elastic bitumen-oil-combination coating.
- Structures subject to external atmospheric exposure including industrial and marine environment (stainless steel).
- Structures subject to permanently damp internal condition, if no particular aggressive conditions exist (stainless steel).
Note: Particular aggressive conditions are e.g. permanent, alternating immersion in seawater or the splash zone of seawater, chloride atmosphere of indoor swimming pools or atmosphere with extreme chemical pollution (e.g. in desulphurization plants or road tunnels where de-icing materials are used).

Design:

- The anchorages are designed in accordance with the ETAG 020, edition March 2012, Annex C under the responsibility of an engineer experienced in anchorages and masonry work.
- Verifiable calculation notes and drawings shall be prepared taking account the loads to be anchored, the nature and strength of the base materials and the dimensions of the anchorage members as well as of the relevant tolerances. The position of the anchor is indicated on the design drawings.
- Anchors are only to be used for multiple fixings for non-structural application, according to ETAG 020, edition March 2012.

Installation:

- Hole shall be drilled by the drill methods or punched by the punch tool given in Annexes C2 and C3 for use categories a, b, c and d; the influence of other drilling methods may be determined by job side tests according to ETAG 020, edition March 2012, Annex B.
- Anchor installation shall be carried out by appropriately qualified personnel and under the supervision of the person responsible for technical matters of the site.
- Installation shall be executed in temperature from -20°C to +40°C.
- Exposure to UV due to solar radiation of the anchor not protected by the mortar shall not exceed 6 weeks.

FF1	Annex B1 of European Technical Assessment ETA-12/0398
Intended use Specifications	

Table B1: Installation parameters

Anchor type		FF1-08L	FF1-10L	FF1-14L	FF1-10K	FF1-14K
Nominal drill hole diameter	d_o [mm]	8	10	14	10	14
Cutting diameter of drill bit	$d_{cut} \leq$ [mm]	8,45	10,45	14,45	10,45	14,45
Depth of drill hole to deepest point	$h_1 \geq$ [mm]	60 / 80 ¹⁾	60 ²⁾ / 80 ³⁾	80	60 ²⁾ / 80 ³⁾	80
Overall embedment depth in the base material	$h_{nom} \geq$ [mm]	50 / 70 ¹⁾	50 ²⁾ / 70 ³⁾	70	50 ²⁾ / 70 ³⁾	70
Diameter of clearance hole in the fixture	$d_r \leq$ [mm]	8,0 – 8,5	10,0 – 10,5	14,0 – 14,5	10,0 – 10,5	14,0 – 14,5
Fixture thickness t_{fix}	t_{fix} [mm]	1 – 110 / 1 – 90 ¹⁾	1 – 250 ²⁾ / 1 – 230 ³⁾	1 – 170	1 – 250 ²⁾ / 1 – 230 ³⁾	1 – 170
Torque wrench	[mm]	TX 30	TX 40	TX 50	SW13 TX 40	SW17 TX 50

1) in case of anchors fixed in aerated autoclaved concrete (AAC)

2) in case of anchors fixed in concrete, clay brick HD (only for FF1 10 PP) or sand-lime brick HD

3) in case of anchors fixed in concrete, clay brick HD (for FF1 10 PP and FF1 10 PA), perforated ceramic brick, calcium silicate hollow block, hollow lightweight aggregate concrete element, hollow ceramic brick or aerated autoclaved concrete (AAC)

Anchor	Maximum installation torque T_{inst} [Nm]	
	concrete and masonry	AAC
FF1-08 PP ($h_{nom} = 50$ mm)	7	–
FF1-08 PP ($h_{nom} = 70$ mm)	–	3,5
FF1-08 PA ($h_{nom} = 50$ mm)	9	–
FF1-08 PA ($h_{nom} = 70$ mm)	–	3,6
FF1-10 PP ($h_{nom} = 50$ mm)	7,4	–
FF1-10 PP ($h_{nom} = 70$ mm)	16	3,8
FF1-10 PA ($h_{nom} = 50$ mm)	16	–
FF1-10 PA ($h_{nom} = 70$ mm)	16	4,3
FF1-14 PP ($h_{nom} = 70$ mm)	15	5,5
FF1-14 PA ($h_{nom} = 70$ mm)	30	6,6

FF1

Intended use
Installation parameters

Annex B2

of European
Technical Assessment
ETA-12/0398

Table B2: Minimum thickness of member, edge distance and anchor spacing in concrete

Anchor diameter	Base material	h_{min} [mm]	$C_{cr,N}$ [mm]	C_{min} [mm]	S_{min} [mm]
Ø8	Concrete ≥ C16/20	100	60 ¹⁾ / 60 ²⁾	60 ¹⁾ / 60 ²⁾	60 ¹⁾ / 60 ²⁾
	Concrete ≥ C12/15	100	84 ¹⁾ / 84 ²⁾	84 ¹⁾ / 84 ²⁾	84 ¹⁾ / 84 ²⁾
Ø10	Concrete ≥ C16/20	100	70 ¹⁾³⁾ / 70 ¹⁾⁴⁾ 90 ²⁾³⁾ / 80 ²⁾⁴⁾	60 ¹⁾³⁾ / 60 ¹⁾⁴⁾ 80 ²⁾³⁾ / 80 ²⁾⁴⁾	60 ¹⁾³⁾ / 60 ¹⁾⁴⁾ 90 ²⁾³⁾ / 95 ²⁾⁴⁾
	Concrete ≥ C12/15	100	98 ¹⁾³⁾ / 98 ¹⁾⁴⁾ 126 ²⁾³⁾ / 112 ²⁾⁴⁾	84 ¹⁾³⁾ / 84 ¹⁾⁴⁾ 112 ²⁾³⁾ / 112 ²⁾⁴⁾	84 ¹⁾³⁾ / 84 ¹⁾⁴⁾ 126 ²⁾³⁾ / 133 ²⁾⁴⁾
Ø14	Concrete ≥ C16/20	100	75 ¹⁾ / 120 ²⁾	80 ¹⁾ / 120 ²⁾	75 ¹⁾ / 120 ²⁾
	Concrete ≥ C12/15	100	105 ¹⁾ / 168 ²⁾	112 ¹⁾ / 168 ²⁾	105 ¹⁾ / 168 ²⁾

- 1) for FF1 PP anchor
- 2) for FF1 PA anchor
- 3) $h_{nom} = 50$ mm
- 4) $h_{nom} = 70$ mm

Scheme of distances and spacing in concrete and masonry

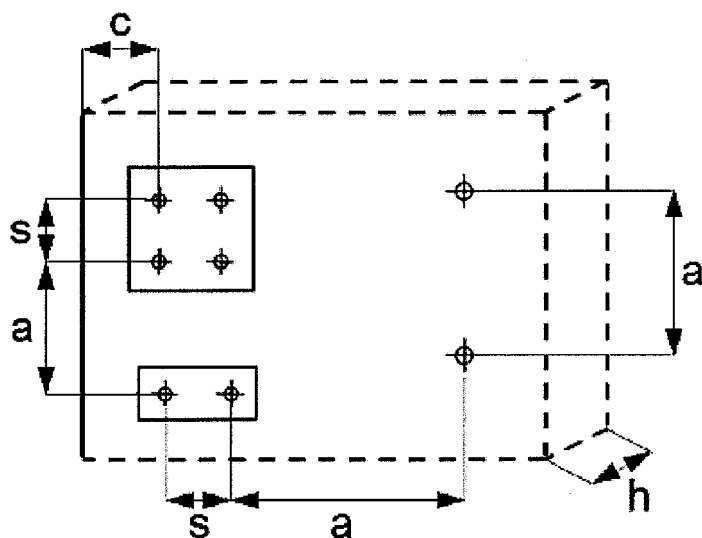

FF1	Annex B3 of European Technical Assessment ETA-12/0398
Intended use Minimum thickness of member, edge distance and anchor spacing in concrete	

Table B3: Minimum thickness of member, edge distance and anchor spacing in masonry

Anchor diameter	Base material (type of element)	Single anchor			Anchor group ¹⁾	
		h_{min} [mm]	c_{min} [mm]	a_{min} [mm]	s_{min1} ²⁾ [mm]	s_{min2} ³⁾ [mm]
Ø8	Clay brick HD ⁶⁾ / Sand-lime brick HD ⁷⁾	125	60	250	200	400
	Perforated ceramic brick ⁸⁾	238	60			
	Perforated ceramic brick ⁹⁾	238	80			
	Calcium silicate hollow block ¹⁰⁾	115	60			
	Hollow lightweight aggregate concrete element ¹¹⁾	249	70			
	Perforated ceramic brick ¹²⁾	113	60			
	Perforated ceramic brick ¹³⁾	240	80	250		
Autoclaved aerated concrete element ¹⁶⁾	100	100				
Ø10	Clay brick HD ⁶⁾ / Sand-lime brick HD ⁷⁾	125	100	250	200	400
	Perforated ceramic brick ⁸⁾	238				
	Perforated ceramic brick ⁹⁾	238				
	Calcium silicate hollow block ¹⁰⁾	115				
	Hollow lightweight aggregate concrete element ¹¹⁾	249				
	Perforated ceramic brick ¹²⁾	113				
	Hollow ceramic brick ¹⁴⁾	115				
	Perforated ceramic brick ¹⁵⁾	200				
	Autoclaved aerated concrete element ¹⁶⁾¹⁷⁾¹⁸⁾	100	70	250	80	70
	Autoclaved aerated concrete element ¹⁶⁾¹⁷⁾¹⁹⁾					80
	Autoclaved aerated concrete element ¹⁶⁾¹⁷⁾²⁰⁾		80	250	110	80
Autoclaved aerated concrete element ¹⁶⁾²¹⁾			400			
Ø14	Clay brick HD ⁶⁾	125	120	250	200	400
	Sand-lime brick HD ⁷⁾	125	110 ⁴⁾ / 150 ⁵⁾			
	Perforated ceramic brick ⁸⁾	238	120			
	Perforated ceramic brick ⁹⁾	238	100 ⁴⁾ / 120 ⁵⁾			
	Calcium silicate hollow block ¹⁰⁾	115	70			
	Hollow lightweight aggregate concrete element ¹¹⁾	249	70			
	Perforated ceramic brick ¹²⁾	113	100 ⁴⁾ / 120 ⁵⁾			
	Perforated ceramic brick ¹³⁾	240	120	250		
Autoclaved aerated concrete element ¹⁶⁾	100	100				

¹⁾ The design method valid for single anchor and anchor groups with two or four anchors

²⁾ In direction perpendicular to free edge

³⁾ In direction parallel to free edge

⁴⁾ For FF1 14 PP anchor

⁵⁾ For FF1 14 PA anchor

⁶⁾ Solid brick according to EN 771-1

⁷⁾ Solid brick according to EN 771-2

⁸⁾ For example perforated brick MAX according to EN 771-1; a = 12 mm, b = 38 mm, c = 8 mm

⁹⁾ Perforated brick Porotherm P+W 25 according to EN 771-1; a = 10,2 mm, b = 38 mm, c = 7 mm

¹⁰⁾ For example calcium silicate hollow block KSL 6DF according to DIN 106 and EN 771-2; a = 22 mm, b = 50 mm, c = 22 mm

¹¹⁾ For example hollow lightweight aggregate concrete element HBL according to EN 771-3; a = 31 mm

¹²⁾ For example perforated brick HLZ 12 according to DIN 105 and EN 771-1; a = 12 mm, b = 32 mm, c = 7 mm, d = 12 mm, e = 13 mm

¹³⁾ For example perforated brick HLZ 15 according to DIN 105 and EN 771-1; a = 17 mm

¹⁴⁾ For example perforated brick Optibric PV according to EN 771-1; a = 10 mm, b = 39 mm, c = 7, d = 38 mm, e = 6,5 mm

¹⁵⁾ For example perforated brick Doppio uni according to EN 771-1; a = 11 mm, b = 24 mm, c = 10 mm

¹⁶⁾ According to EN 771-4

¹⁷⁾ Drill method: punch tool (see Annex A)

¹⁸⁾ AAC2

¹⁹⁾ AAC4

²⁰⁾ AAC5

²¹⁾ AAC6

FF1

Intended use

Minimum thickness of member, edge distance and anchor spacing in masonry

Annex B4

of European
Technical Assessment
ETA-12/0398

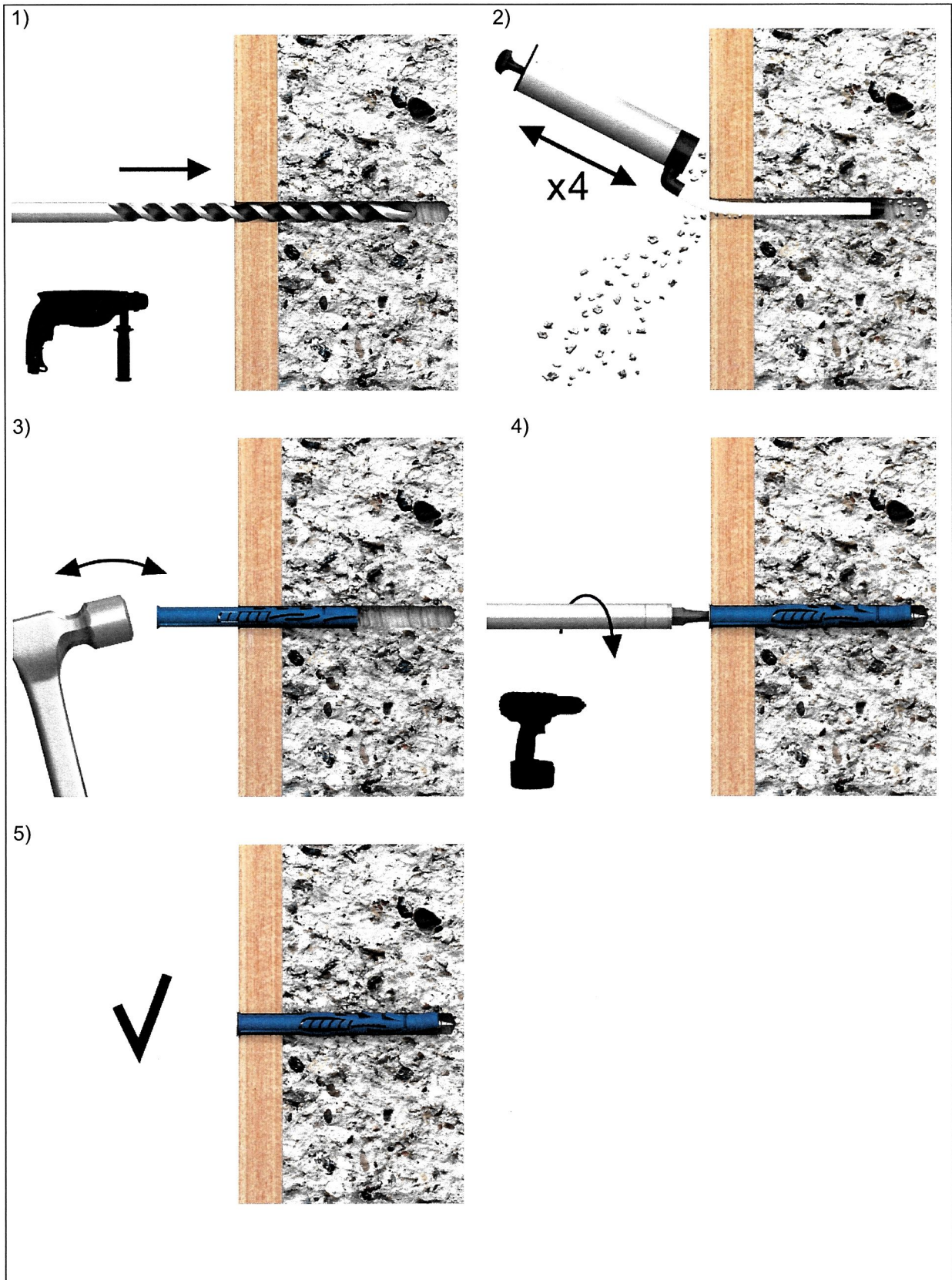

<p>FF1</p>	<p>Annex B5</p>
<p>Intended use Installation instruction of FF1 L anchors</p>	<p>of European Technical Assessment ETA-12/0398</p>

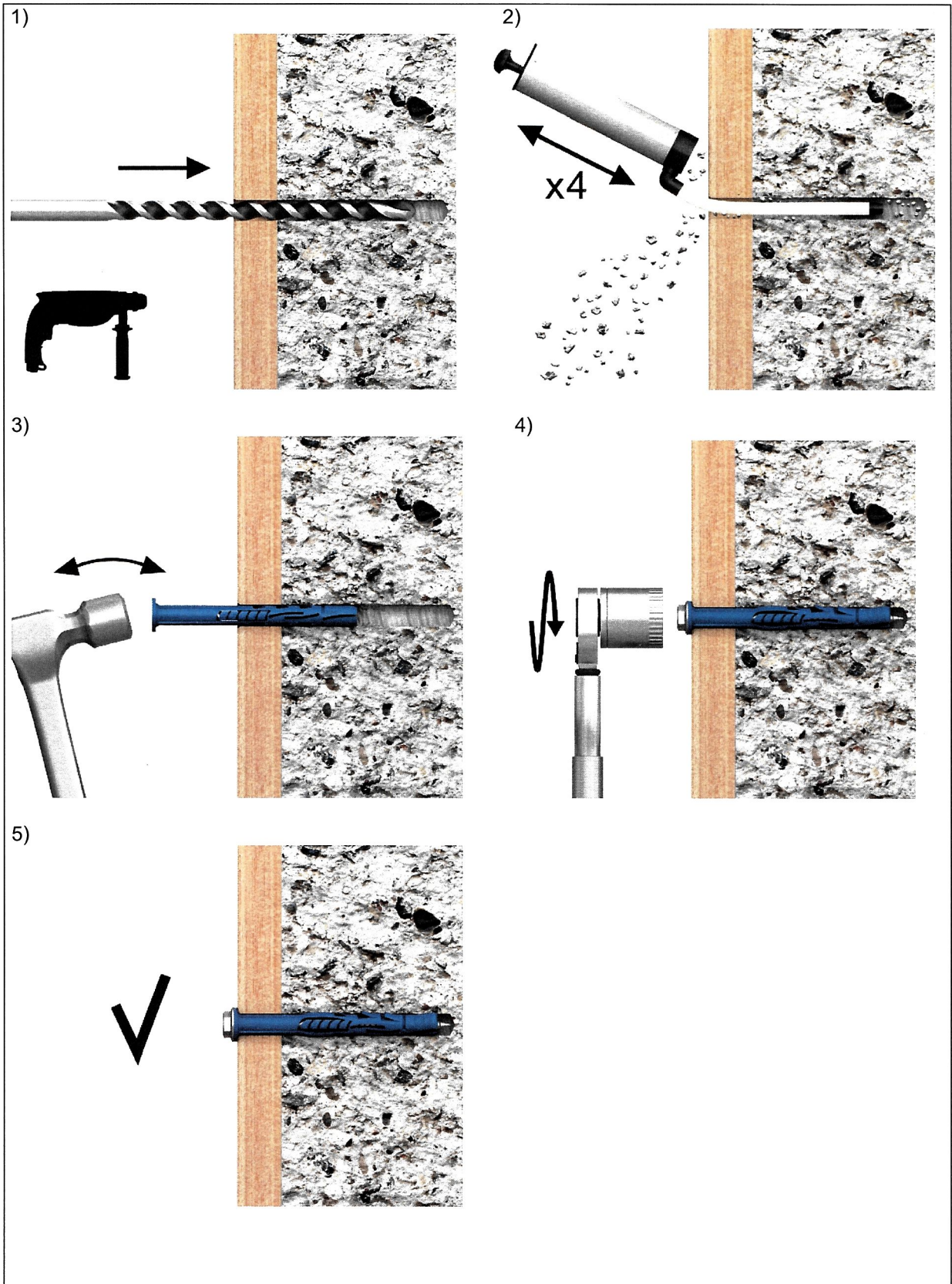

<p>FF1</p>	<p>Annex B6</p>
<p>Intended use Installation instruction of FF1 K anchors</p>	<p>of European Technical Assessment ETA-12/0398</p>

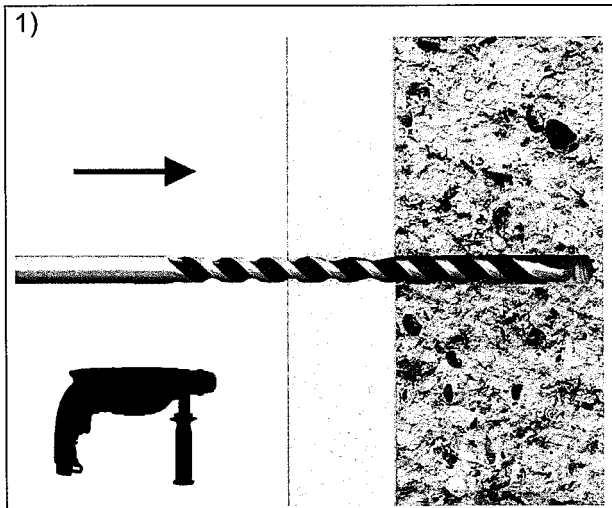
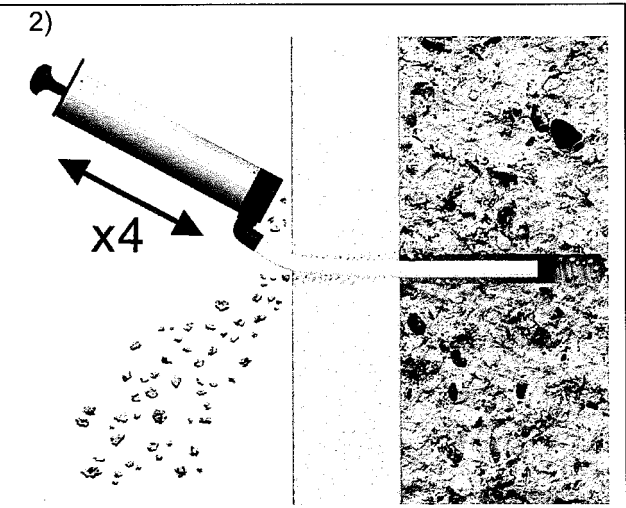
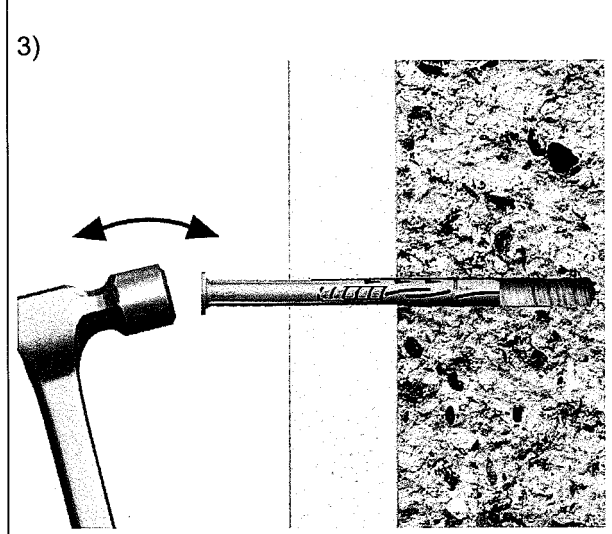
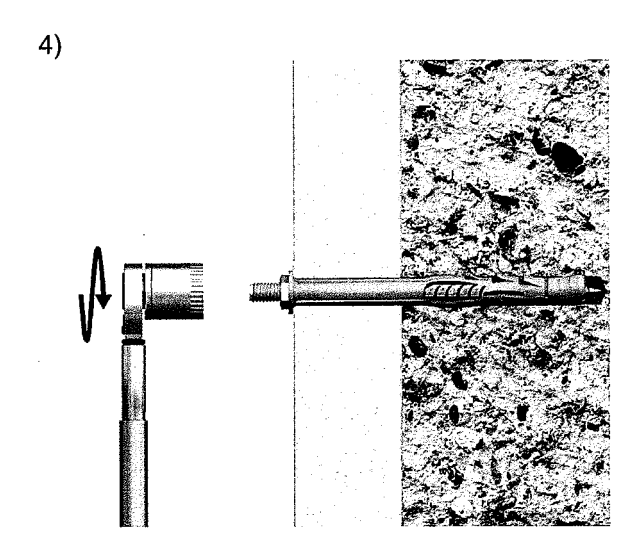
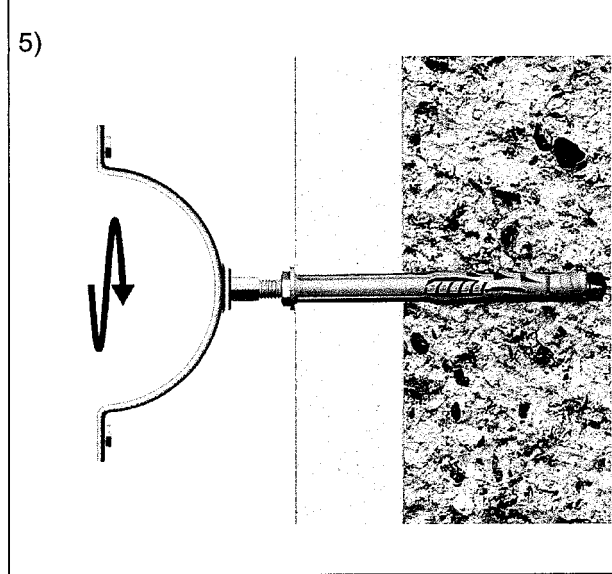
<p>1)</p> 	<p>2)</p> 
<p>3)</p> 	<p>4)</p> 
<p>5)</p> 	
FF1	Annex B7
Intended use Installation instruction of FF1 K anchors with special screw for clamps of drain pipes	of European Technical Assessment ETA-12/0398

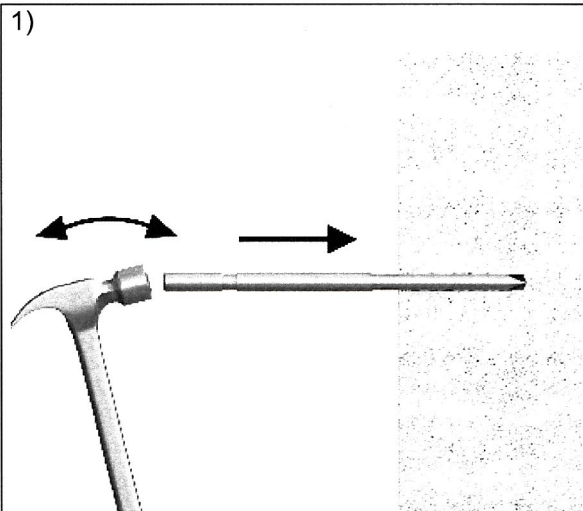
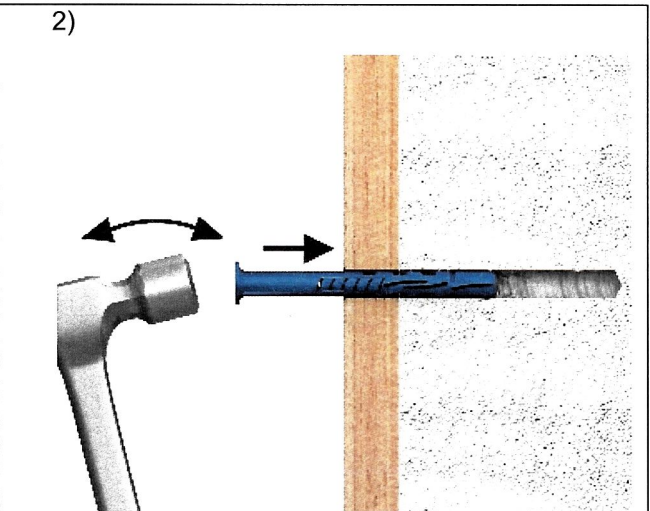
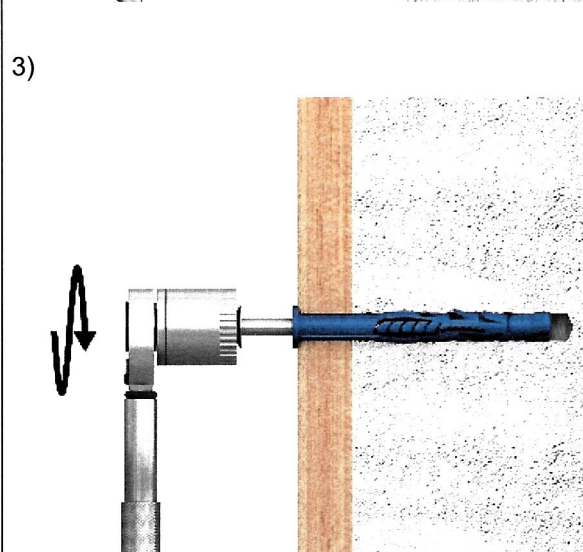
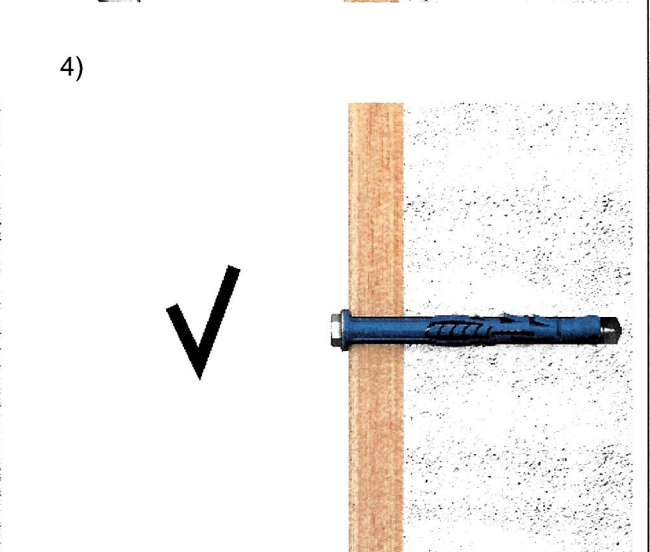
<p>1)</p> 	<p>2)</p> 
<p>3)</p> 	<p>4)</p> 
<p>FF1</p>	<p>Annex B8</p>
<p>Intended use Installation instruction of FF1 anchors with punch-tool</p>	<p>of European Technical Assessment ETA-12/0398</p>

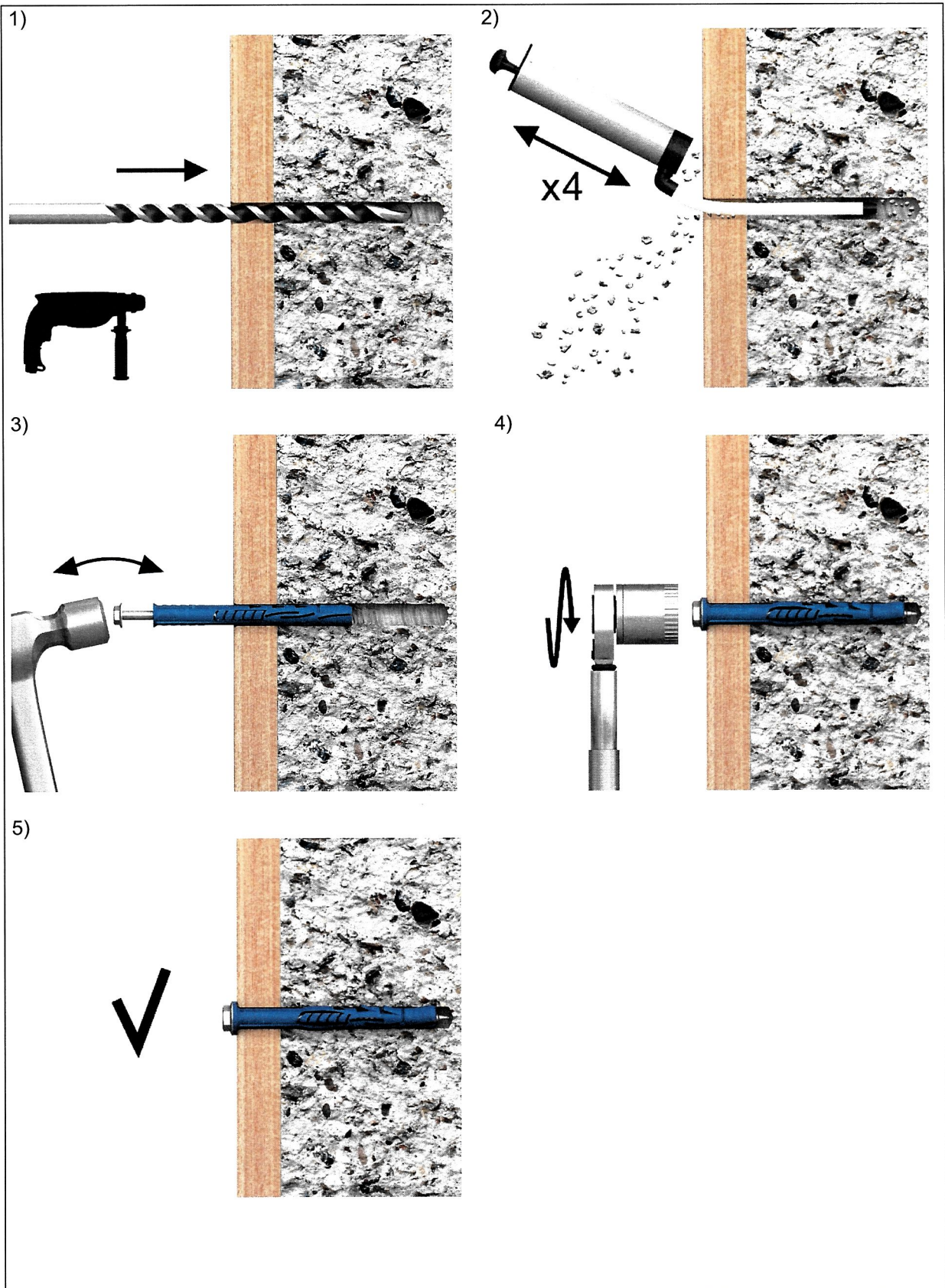

<p>FF1</p>	<p>Annex B9 of European Technical Assessment ETA-12/0398</p>
<p>Intended use Installation instruction of pre-assembled FF1 anchors</p>	

Table C1: Characteristic bending resistance of the screw in concrete and masonry

Anchor diameter		Ø8		Ø10		Ø14	
		carbon steel ¹⁾	stainless steel	carbon steel ¹⁾	stainless steel	carbon steel ¹⁾	stainless steel
Characteristic bending resistance	$M_{Rk,s}$ [Nm]	5,1 ³⁾ 7,1 ⁴⁾	7,3	9,2 ³⁾ 12,6 ⁴⁾ 17,4 ⁵⁾	13,1	39,8 ³⁾ 54,9 ⁴⁾	56,8
Partial safety factor	$\gamma_{Ms}^{2)}$	1,61 ³⁾ 1,38 ⁴⁾	1,42	1,61 ³⁾ 1,38 ⁴⁾ 1,25 ⁵⁾	1,42	1,61 ³⁾ 1,38 ⁴⁾	1,42

¹⁾ Steel with electroplated zinc coating or steel with zinc flake coating

²⁾ In absence of other national regulations

³⁾ Type a: $f_{y,k} \geq 260$ MPa, $f_{u,k} \geq 420$ MPa, with "•" on the head marking

⁴⁾ Type b: $f_{y,k} \geq 420$ MPa, $f_{u,k} \geq 580$ MPa

⁵⁾ High-load: $f_{y,k} \geq 640$ MPa, $f_{u,k} \geq 800$ MPa, with "H" on the head marking

Table C2: Characteristic resistance of the screw for use in concrete, failure of expansion element (screw)

Anchor diameter		Ø8		Ø10		Ø14	
		carbon steel ¹⁾	stainless steel	carbon steel ¹⁾	stainless steel	carbon steel ¹⁾	stainless steel
Characteristic tension resistance	$N_{Rk,s}$ [kN]	7,3 ³⁾ 10,0 ⁴⁾	10,4	10,7 ³⁾ 14,8 ⁴⁾ 20,4 ⁵⁾	15,3	28,5 ³⁾ 39,4 ⁴⁾	40,7
Partial safety factor	$\gamma_{Ms}^{2)}$	1,94 ³⁾ 1,66 ⁴⁾	1,71	1,94 ³⁾ 1,66 ⁴⁾ 1,5 ⁵⁾	1,71	1,94 ³⁾ 1,66 ⁴⁾	1,71
Characteristic shear resistance	$V_{Rk,s}$ [kN]	3,6 ³⁾ 5,0 ⁴⁾	5,2	5,4 ³⁾ 7,4 ⁴⁾ 10,2 ⁵⁾	7,7	14,3 ³⁾ 19,7 ⁴⁾	20,4
Partial safety factor	$\gamma_{Ms}^{2)}$	1,61 ³⁾ 1,38 ⁴⁾	1,42	1,61 ³⁾ 1,38 ⁴⁾ 1,25 ⁵⁾	1,42	1,61 ³⁾ 1,38 ⁴⁾	1,42

¹⁾ Steel with electroplated zinc coating or steel with zinc flake coating

²⁾ In absence of other national regulations

³⁾ Type a: $f_{y,k} \geq 260$ MPa, $f_{u,k} \geq 420$ MPa, with "•" on the head marking

⁴⁾ Type b: $f_{y,k} \geq 420$ MPa, $f_{u,k} \geq 580$ MPa

⁵⁾ High-load: $f_{y,k} \geq 640$ MPa, $f_{u,k} \geq 800$ MPa, with "H" on the head marking

FF1

Performances
Characteristic resistance of the screw

Annex C1
of European
Technical Assessment
ETA-12/0398

Table C3: Characteristic resistance for use in cracked and non-cracked concrete, pull-out failure (plastic sleeve); hammer drilling

Anchor diameter		Ø8	Ø10	Ø14
Concrete ≥ C16/20				
Characteristic resistance	$N_{Rk,p}$ [kN]	0,9 ¹⁾³⁾	0,9 ¹⁾³⁾	2,5 ¹⁾⁴⁾
		2,0 ²⁾³⁾	1,2 ¹⁾⁴⁾ 2,0 ²⁾³⁾ 5,5 ²⁾⁴⁾	5,5 ²⁾⁴⁾
Partial safety factor	γ_{Mc} ⁵⁾	1,8		
Concrete ≥ C12/15				
Characteristic resistance	$N_{Rk,p}$ [kN]	0,6 ¹⁾³⁾	0,5 ¹⁾³⁾	2,0 ¹⁾⁴⁾
		1,5 ²⁾³⁾	0,9 ¹⁾⁴⁾ 1,2 ²⁾³⁾ 4,0 ²⁾⁴⁾	4,0 ²⁾⁴⁾
Partial safety factor	γ_{Mc} ⁵⁾	1,8		

Valid for all ranges of temperatures according to Annex B1

1) FF1 PP; 2) FF1 PA 3) $h_{nom} = 50$ mm; 4) $h_{nom} = 70$ mm

5) In absence of other national regulations

Table C4: Displacements under tension and shear loading in concrete⁵⁾⁶⁾

Anchor diameter	Tension load			Shear load		
	N [kN]	δ_{N0} [mm]	$\delta_{N\infty}$ [mm]	V [kN]	δ_{V0} [mm]	$\delta_{V\infty}$ [mm]
Ø8	0,36 ¹⁾³⁾ 0,79 ²⁾³⁾	0,95 ¹⁾³⁾ 1,11 ²⁾³⁾	1,90 ¹⁾³⁾ 2,22 ²⁾³⁾	0,36 ¹⁾³⁾ 0,79 ²⁾³⁾	0,18	0,27
Ø10	0,36 ¹⁾³⁾ 0,47 ¹⁾⁴⁾ 0,79 ²⁾³⁾ 3,37 ²⁾⁴⁾	0,38 ¹⁾³⁾ 0,55 ¹⁾⁴⁾ 0,67 ²⁾³⁾ 1,95 ²⁾⁴⁾	0,76 ¹⁾³⁾ 1,10 ¹⁾⁴⁾ 1,34 ²⁾³⁾ 3,90 ²⁾⁴⁾	0,36 ¹⁾³⁾ 0,47 ¹⁾⁴⁾ 0,79 ²⁾³⁾ 3,37 ²⁾⁴⁾	0,11	0,16
Ø14	0,99 ¹⁾⁴⁾ 2,18 ²⁾⁴⁾	1,56 ¹⁾⁴⁾ 1,70 ²⁾⁴⁾	3,12 ¹⁾⁴⁾ 3,40 ²⁾⁴⁾	0,99 ¹⁾⁴⁾ 2,18 ²⁾⁴⁾	0,43	0,64

1) FF1 PP; 2) FF1 PA; 3) $h_{nom} = 50$ mm; 4) $h_{nom} = 70$ mm

5) Valid for all ranges of temperatures

6) Intermediate values by linear interpolation

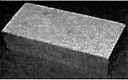



Table C5: Characteristic values F_{Rk} in any load direction under fire exposure in concrete C20/25 to C50/60, no permanent centric tension load and shear load with lever arm

Anchor diameter	Fire resistance class	F_{Rk} [kN]
Ø10 ¹⁾²⁾³⁾ Ø14 ¹⁾²⁾³⁾	R90	0,8

1) FF1 PA; 2) $h_{nom} = 50$ mm; 3) $h_{nom} = 70$ mm

FF1	Annex C2 of European Technical Assessment ETA-12/0398
Performances Characteristic resistance in concrete (use category a), displacements in concrete, resistance to fire	

Table C6: Characteristic resistance F_{Rk} [kN] of FF1-08 anchor in masonry

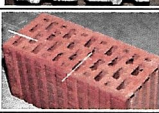
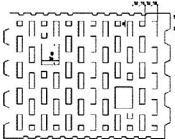
Base material	Bulk density class [kg/dm ³]	Compressive strength class [N/mm ²]	Picture	Drill method	F_{Rk} ¹⁴⁾ [kN]
Clay brick HD ⁵⁾	≥ 1,80	≥ 20		hammer	1,2 ¹⁾ / 1,5 ²⁾ - ³⁾ / - ⁴⁾
Sand-lime brick HD ⁶⁾	≥ 1,80	≥ 20		hammer	0,75 ¹⁾ / 1,5 ²⁾ - ³⁾ / - ⁴⁾
Perforated ceramic brick ⁷⁾	≥ 0,80	≥ 15		rotary drilling only	0,5 ¹⁾ / 0,75 ²⁾ - ³⁾ / - ⁴⁾
Perforated ceramic brick ⁸⁾	≥ 0,80	≥ 15		rotary drilling only	0,3 ¹⁾ / 0,4 ²⁾ - ³⁾ / - ⁴⁾
Calcium silicate hollow block ⁹⁾	≥ 1,60	≥ 20		rotary drilling only	0,4 ¹⁾ / 0,5 ²⁾ - ³⁾ / - ⁴⁾
Hollow lightweight aggregate concrete element ¹⁰⁾	≥ 0,80	≥ 2		rotary drilling only	0,5 ¹⁾ / 0,9 ²⁾ - ³⁾ / - ⁴⁾
Perforated ceramic brick ¹¹⁾	≥ 0,90	≥ 12		rotary drilling only	0,4 ¹⁾ / 0,6 ²⁾ - ³⁾ / - ⁴⁾
Perforated ceramic brick ¹²⁾	≥ 0,90	≥ 15		rotary drilling only	0,75 ¹⁾ / 1,2 ²⁾ - ³⁾ / - ⁴⁾
Autoclaved aerated concrete AAC 2 ¹³⁾	≥ 0,35	≥ 2	–	rotary drilling only	- ¹⁾ / - ²⁾ 0,5 ³⁾ / 0,4 ⁴⁾
Autoclaved aerated concrete AAC 6 ¹³⁾	≥ 0,65	≥ 6	–	rotary drilling only	- ¹⁾ / - ²⁾ 1,2 ³⁾ / 0,9 ⁴⁾
Partial safety factor ¹⁵⁾	$\gamma_{Mm} / \gamma_{MAAC}$	2,5 / 2,0			

1) FF1-08 PP ($h_{nom} = 50$ mm); 2) FF1-08 PA ($h_{nom} = 50$ mm); 3) FF1-08 PP ($h_{nom} = 70$ mm); 4) FF1-08 PA ($h_{nom} = 70$ mm)

5) According to EN 771-1; 6) According to EN 771-2

7) For example perforated brick MAX according to EN 771-1; a = 12 mm, b = 38 mm, c = 8 mm

8) For example perforated brick Porotherm P+W 25 according to EN 771-1; a = 10,2 mm, b = 38 mm, c = 7 mm

9) For example calcium silicate hollow block KSL 6DF according to DIN 106 and EN 771-2; a = 22 mm, b = 50 mm, c = 22 mm

10) For example hollow lightweight aggregate concrete element HBL according to EN 771-3; a = 31 mm

11) For example perforated brick HLZ 12 according to DIN 105 and EN 771-1; a = 12 mm, b = 32 mm, c = 7 mm, d = 12 mm, e = 13 mm

12) For example perforated brick HLZ 15 according to DIN 105 and EN 771-1; a = 17 mm

13) According to EN 771-4

14) Characteristic resistance F_{Rk} for tension, shear or combined tension and shear loading

The characteristic resistance is valid for single plastic anchor or for a group of two or four plastic anchors with a spacing equal or larger than the minimum spacing s_{min} according to table B3 (Annex B4)

15) Partial safety factor for use in masonry $\gamma_{Mm} = 2,5$ and partial safety factor for use in autoclaved aerated concrete $\gamma_{MAAC} = 2,0$ in absence of other national regulations





FF1

Performances of FF1-08 anchor
Characteristic resistance in masonry (use category b, c and d)

Annex C3

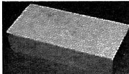
of European
Technical Assessment
ETA-12/0398

Table C7: Characteristic resistance F_{Rk} [kN] of FF1-10 anchor in masonry

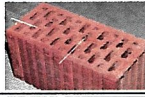
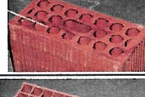
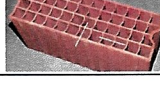
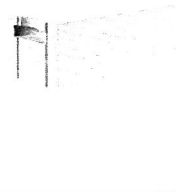
Base material	Bulk density class [kg/dm ³]	Compressive strength class [N/mm ²]	Picture	Drill method	F_{Rk}^{15} [kN]
Clay brick HD ⁵⁾	≥ 1,80	≥ 50		hammer	1,5 ¹⁾ / ₋₂₎ 2,5 ³⁾ / 5,0 ⁴⁾
Sand-lime brick HD ⁶⁾	≥ 1,80	≥ 30		hammer	1,2 ¹⁾ / 1,5 ²⁾ ₋₃₎ / ₋₄₎
Perforated ceramic brick ⁷⁾	≥ 0,80	≥ 15		rotary drilling only	₋₁₎ / ₋₂₎ 0,5 ³⁾ / 1,5 ⁴⁾
Perforated ceramic brick ⁸⁾	≥ 0,80	≥ 15		rotary drilling only	₋₁₎ / ₋₂₎ 0,6 ³⁾ / 1,5 ⁴⁾
Calcium silicate hollow block ⁹⁾	≥ 1,60	≥ 20		rotary drilling only	₋₁₎ / ₋₂₎ 0,75 ³⁾ / 3,5 ⁴⁾
Hollow lightweight aggregate concrete element ¹⁰⁾	≥ 0,80	≥ 2		rotary drilling only	₋₁₎ / ₋₂₎ 0,3 ³⁾ / 0,9 ⁴⁾
Perforated ceramic brick ¹¹⁾	≥ 0,90	≥ 12		rotary drilling only	₋₁₎ / ₋₂₎ 0,5 ³⁾ / 0,9 ⁴⁾
Perforated ceramic brick ¹²⁾	≥ 0,91	≥ 15		rotary drilling only	₋₁₎ / ₋₂₎ 0,6 ³⁾ / 0,75 ⁴⁾
Hollow ceramic brick ¹³⁾	≥ 0,60	≥ 7,5		rotary drilling only	₋₁₎ / ₋₂₎ 0,3 ³⁾ / 0,75 ⁴⁾
Autoclaved aerated concrete AAC 2 ¹⁴⁾	≥ 0,35	≥ 2		rotary drilling only	₋₁₎ / ₋₂₎ 0,5 ³⁾ / 0,4 ⁴⁾
Autoclaved aerated concrete AAC 6 ¹⁴⁾	≥ 0,65	≥ 6		rotary drilling only	₋₁₎ / ₋₂₎ 1,2 ³⁾ / 0,9 ⁴⁾
Autoclaved aerated concrete AAC 2 ¹⁴⁾	≥ 0,35	≥ 2		punch tool	₋₁₎ / ₋₂₎ ₋₃₎ / 0,4 ⁴⁾ 17)
Autoclaved aerated concrete AAC 4 ¹⁴⁾	≥ 0,70	≥ 4		punch tool	₋₁₎ / ₋₂₎ ₋₃₎ / 0,9 ⁴⁾ 17)
Autoclaved aerated concrete AAC 5 ¹⁴⁾	≥ 0,70	≥ 5		punch tool	₋₁₎ / ₋₂₎ ₋₃₎ / 1,2 ⁴⁾ 17)
Partial safety factor ¹⁶⁾	$\gamma_{Mm} / \gamma_{MAcC}$	2,5 / 2,0			

1) FF1-10 PP ($h_{nom} = 50$ mm); 2) FF1-10 PA ($h_{nom} = 50$ mm); 3) FF1-10 PP ($h_{nom} = 70$ mm); 4) FF1-10 PA ($h_{nom} = 70$ mm)

5) According to EN 771-1; 6) According to EN 771-2

7) For example perforated brick MAX according to EN 771-1; a = 12 mm, b = 38 mm, c = 8 mm

8) For example perforated brick Porotherm P+W 25 according to EN 771-1; a = 10,2 mm, b = 38 mm, c = 7 mm

9) For example calcium silicate hollow block KSL 6DF according to DIN 106 and EN 771-2; a = 22 mm, b = 50 mm, c = 22 mm

10) For example hollow lightweight aggregate concrete element HBL according to EN 771-3; a = 31 mm

11) For example perforated brick HLZ 12 according to DIN 105 and EN 771-1; a = 12 mm, b = 32 mm, c = 7 mm, d = 12 mm, e = 13 mm

12) For example perforated brick Doppio uni according to EN 771-1; a = 11 mm, b = 24 mm, c = 10 mm

13) For example perforated brick Optibric PV according to EN 771-1; a = 10 mm, b = 39 mm, c = 7, d = 38 mm, e = 6,5 mm

14) According to EN 771-4

15) Characteristic resistance F_{Rk} for tension, shear or combined tension and shear loading







The characteristic resistance is valid for single plastic anchor or for a group of two or four plastic anchors with a spacing equal or larger than the minimum spacing s_{min} according to table B3 (Annex B4)

16) Partial safety factor for use in masonry $\gamma_{Mm} = 2,5$ and partial safety factor for use in autoclaved aerated concrete $\gamma_{MAcC} = 2,0$ in absence of other national regulations

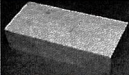
17) Drill method: punch tool (see Annex A)

FF1	Annex C3
Performances of FF1-10 anchor Characteristic resistance in masonry (use category b, c and d)	of European Technical Assessment ETA-12/0398

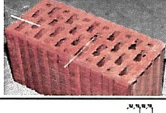
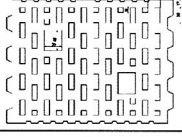
Table C8: Characteristic resistance F_{Rk} [kN] of FF1-14 anchor in masonry

Base material	Bulk density class [kg/dm ³]	Compressive strength class [N/mm ²]	Picture	Drill method	$F_{Rk}^{(12)}$ [kN]
Clay brick HD ³⁾	≥ 1,80	≥ 20		hammer	4,0 ¹⁾ / 4,5 ²⁾
Sand-lime brick HD ⁴⁾	≥ 1,80	≥ 20		hammer	3,0 ¹⁾ / 3,5 ²⁾
Perforated ceramic brick ⁵⁾	≥ 0,80	≥ 15		rotary drilling only	0,9 ¹⁾ / 1,2 ²⁾
Perforated ceramic brick ⁶⁾	≥ 0,80	≥ 15		rotary drilling only	0,9 ¹⁾ / 1,2 ²⁾
Calcium silicate hollow block ⁷⁾	≥ 1,60	≥ 20		rotary drilling only	0,9 ¹⁾ / 1,2 ²⁾
Hollow lightweight aggregate concrete element ⁸⁾	≥ 0,80	≥ 2		rotary drilling only	1,2 ¹⁾ / 1,2 ²⁾
Perforated ceramic brick ⁹⁾	≥ 0,90	≥ 12		rotary drilling only	1,5 ¹⁾ / 0,9 ²⁾
Perforated ceramic brick ¹⁰⁾	≥ 0,90	≥ 15		rotary drilling only	1,5 ¹⁾ / 1,5 ²⁾
Autoclaved aerated concrete AAC 2 ¹¹⁾	≥ 0,35	≥ 2		rotary drilling only	0,75 ¹⁾ / 0,6 ²⁾
Autoclaved aerated concrete AAC 6 ¹¹⁾	≥ 0,65	≥ 6		rotary drilling only	2,5 ¹⁾ / 1,5 ²⁾
Partial safety factor ¹³⁾	$\gamma_{Mm} / \gamma_{MAcc}$	2,5 / 2,0			

¹⁾ FF1-14 PP ($h_{nom} = 70$ mm); ²⁾ FF1-14 PA ($h_{nom} = 70$ mm)

³⁾ According to EN 771-1; ⁴⁾ According to EN 771-2

⁵⁾ For example perforated brick MAX according to EN 771-1; a = 12 mm, b = 38 mm, c = 8 mm

⁶⁾ For example perforated brick Porotherm P+W 25 according to EN 771-1; a = 10,2 mm, b = 38 mm, c = 7 mm

⁷⁾ For example calcium silicate hollow block KSL 6DF according to DIN 106 and EN 771-2; a = 22 mm, b = 50 mm, c = 22 mm

⁸⁾ For example hollow lightweight aggregate concrete element HBL according to EN 771-3; a = 31 mm

⁹⁾ For example perforated brick HLZ 12 according to DIN 105 and EN 771-1; a = 12 mm, b = 32 mm, c = 7 mm, d = 12 mm, e = 13 mm

¹⁰⁾ For example perforated brick HLZ 15 according to DIN 105 and EN 771-1; a = 17 mm

¹¹⁾ According to EN 771-4

¹²⁾ Characteristic resistance F_{Rk} for tension, shear or combined tension and shear loading

The characteristic resistance is valid for single plastic anchor or for a group of two or four plastic anchors with a spacing equal or larger than the minimum spacing s_{min} according to table B3 (Annex B4)

¹³⁾ Partial safety factor for use in masonry $\gamma_{Mm} = 2,5$ and partial safety factor for use in autoclaved aerated concrete $\gamma_{MAcc} = 2,0$ in absence of other national regulations

FF1

Performances of FF1-14 anchor

Characteristic resistance in masonry (use category b, c and d)

Annex C3

of European
Technical Assessment
ETA-12/0398

Table C9: Displacements under tension and shear loading of FF1-08 anchor in masonry

Anchor type	Base material	Tension load			Shear load		
		N [kN]	δ_{N0} [mm]	$\delta_{N\infty}$ [mm]	V [kN]	δ_{V0} [mm]	$\delta_{V\infty}$ [mm]
FF1-08	Clay brick HD ⁵⁾	0,34 ¹⁾ /0,43 ²⁾ – 3)/-4)	1,13 ¹⁾ /0,68 ²⁾ – 3)/-4)	2,26 ¹⁾ /1,36 ²⁾ – 3)/-4)	0,34 ¹⁾ /0,43 ²⁾ – 3)/-4)	0,28 ¹⁾ /0,36 ²⁾ – 3)/-4)	0,42 ¹⁾ /0,54 ²⁾ – 3)/-4)
	Sand-lime brick HD ⁶⁾	0,21 ¹⁾ /0,43 ²⁾ – 3)/-4)	0,48 ¹⁾ /1,14 ²⁾ – 3)/-4)	0,96 ¹⁾ /2,28 ²⁾ – 3)/-4)	0,21 ¹⁾ /0,43 ²⁾ – 3)/-4)	0,17 ¹⁾ /0,36 ²⁾ – 3)/-4)	0,26 ¹⁾ /0,54 ²⁾ – 3)/-4)
	Perforated ceramic brick ⁷⁾	0,14 ¹⁾ /0,21 ²⁾ – 3)/-4)	0,64 ¹⁾ /0,63 ²⁾ – 3)/-4)	1,28 ¹⁾ /1,26 ²⁾ – 3)/-4)	0,14 ¹⁾ /0,21 ²⁾ – 3)/-4)	0,12 ¹⁾ /0,17 ²⁾ – 3)/-4)	0,18 ¹⁾ /0,25 ²⁾ – 3)/-4)
	Perforated ceramic brick ⁸⁾	0,09 ¹⁾ /0,11 ²⁾ – 3)/-4)	0,37 ¹⁾ /0,46 ²⁾ – 3)/-4)	0,74 ¹⁾ /0,92 ²⁾ – 3)/-4)	0,09 ¹⁾ /0,11 ²⁾ – 3)/-4)	0,08 ¹⁾ /0,09 ²⁾ – 3)/-4)	0,12 ¹⁾ /0,14 ²⁾ – 3)/-4)
	Calcium silicate hollow block ⁹⁾	0,11 ¹⁾ /0,14 ²⁾ – 3)/-4)	0,61 ¹⁾ /0,65 ²⁾ – 3)/-4)	1,22 ¹⁾ /1,30 ²⁾ – 3)/-4)	0,11 ¹⁾ /0,14 ²⁾ – 3)/-4)	0,09 ¹⁾ /0,12 ²⁾ – 3)/-4)	0,14 ¹⁾ /0,18 ²⁾ – 3)/-4)
	Hollow lightweight aggregate concrete element ¹⁰⁾	0,14 ¹⁾ /0,26 ²⁾ – 3)/-4)	0,21 ¹⁾ /0,42 ²⁾ – 3)/-4)	0,42 ¹⁾ /0,84 ²⁾ – 3)/-4)	0,14 ¹⁾ /0,26 ²⁾ – 3)/-4)	0,12 ¹⁾ /0,22 ²⁾ – 3)/-4)	0,18 ¹⁾ /0,33 ²⁾ – 3)/-4)
	Perforated ceramic brick ¹¹⁾	0,11 ¹⁾ /0,17 ²⁾ – 3)/-4)	0,41 ¹⁾ /0,41 ²⁾ – 3)/-4)	0,82 ¹⁾ /0,82 ²⁾ – 3)/-4)	0,11 ¹⁾ /0,17 ²⁾ – 3)/-4)	0,09 ¹⁾ /0,14 ²⁾ – 3)/-4)	0,14 ¹⁾ /0,21 ²⁾ – 3)/-4)
	Perforated ceramic brick ¹²⁾	0,21 ¹⁾ /0,34 ²⁾ – 3)/-4)	0,43 ¹⁾ /0,87 ²⁾ – 3)/-4)	0,86 ¹⁾ /1,74 ²⁾ – 3)/-4)	0,21 ¹⁾ /0,34 ²⁾ – 3)/-4)	0,17 ¹⁾ /0,28 ²⁾ – 3)/-4)	0,26 ¹⁾ /0,42 ²⁾ – 3)/-4)
	Autoclaved aerated concrete AAC 2 ¹³⁾	- ¹⁾ / ₋₂₎ 0,18 ³⁾ / 0,14 ⁴⁾	- ¹⁾ / ₋₂₎ 0,65 ³⁾ / 0,52 ⁴⁾	- ¹⁾ / ₋₂₎ 1,30 ³⁾ /1,04 ⁴⁾	- ¹⁾ / ₋₂₎ 0,18 ³⁾ / 0,14 ⁴⁾	- ¹⁾ / ₋₂₎ 0,36 ³⁾ / 0,28 ⁴⁾	- ¹⁾ / ₋₂₎ 0,54 ³⁾ / 0,42 ⁴⁾
	Autoclaved aerated concrete AAC 6 ¹³⁾	- ¹⁾ / ₋₂₎ 0,43 ³⁾ / 0,32 ⁴⁾	- ¹⁾ / ₋₂₎ 1,11 ³⁾ / 0,78 ⁴⁾	- ¹⁾ / ₋₂₎ 2,22 ³⁾ / 1,56 ⁴⁾	- ¹⁾ / ₋₂₎ 0,43 ³⁾ / 0,32 ⁴⁾	- ¹⁾ / ₋₂₎ 0,86 ³⁾ / 0,64 ⁴⁾	- ¹⁾ / ₋₂₎ 1,29 ³⁾ / 0,96 ⁴⁾

1) FF1-08 PP ($h_{nom} = 50$ mm)2) FF1-08 PA ($h_{nom} = 50$ mm)3) FF1-08 PP ($h_{nom} = 70$ mm)4) FF1-08 PA ($h_{nom} = 70$ mm)

5) According to EN 771-1

6) According to EN 771-2

7) For example perforated brick MAX according to EN 771-1; a = 12 mm, b = 38 mm, c = 8 mm

8) For example perforated brick Porotherm P+W 25 according to EN 771-1; a = 10,2 mm, b = 38 mm, c = 7 mm

9) For example calcium silicate hollow block KSL 6DF according to DIN 106 and EN 771-2; a = 22 mm, b = 50 mm, c = 22 mm

10) For example hollow lightweight aggregate concrete element HBL according to EN 771-3; a = 31 mm

11) For example perforated brick HLZ 12 according to DIN 105 and EN 771-1; a = 12 mm, b = 32 mm, c = 7 mm, d = 12 mm, e = 13 mm

12) For example perforated brick HLZ 15 according to DIN 105 and EN 771-1; a = 17 mm

13) According to EN 771-4

FF1

Performances of FF1-08 anchor
Displacements in masonry

Annex C4

of European
Technical Assessment
ETA-12/0398

Table C10: Displacements under tension and shear loading of FF1-10 anchor in masonry

Anchor type	Base material	Tension load			Shear load		
		N [kN]	δ_{N0} [mm]	$\delta_{N\infty}$ [mm]	V [kN]	δ_{V0} [mm]	$\delta_{V\infty}$ [mm]
FF1-10	Clay brick HD ⁵⁾	0,43 ¹⁾ /0,71 ²⁾ – – ³⁾ /1,43 ⁴⁾	0,30 ¹⁾ /0,51 ²⁾ – – ³⁾ /1,45 ⁴⁾	0,6 ¹⁾ /1,02 ²⁾ – ³⁾ /2,90 ⁴⁾	0,43 ¹⁾ /0,71 ²⁾ – – ³⁾ /1,43 ⁴⁾	0,36 ¹⁾ /0,59 ²⁾ – – ³⁾ /1,19 ⁴⁾	0,54 ¹⁾ /0,88 ²⁾ – – ³⁾ /1,79 ⁴⁾
	Sand-lime brick HD ⁶⁾	0,34 ¹⁾ /– ²⁾ 0,43 ³⁾ /– ⁴⁾	0,69 ¹⁾ /– ²⁾ 0,33 ³⁾ /– ⁴⁾	1,38 ¹⁾ /– ²⁾ 0,66 ³⁾ /– ⁴⁾	0,34 ¹⁾ /– ²⁾ 0,43 ³⁾ /– ⁴⁾	0,28 ¹⁾ /– ²⁾ 0,36 ³⁾ /– ⁴⁾	0,42 ¹⁾ /– ²⁾ 0,54 ³⁾ /– ⁴⁾
	Perforated ceramic brick ⁷⁾	– ¹⁾ /0,14 ²⁾ – ³⁾ /0,43 ⁴⁾	– ¹⁾ /0,08 ²⁾ – ³⁾ /0,87 ⁴⁾	– ¹⁾ /0,16 ²⁾ – ³⁾ /1,74 ⁴⁾	– ¹⁾ /0,14 ²⁾ – ³⁾ /0,43 ⁴⁾	– ¹⁾ /0,12 ²⁾ – ³⁾ /0,36 ⁴⁾	– ¹⁾ /0,18 ²⁾ – ³⁾ /0,54 ⁴⁾
	Perforated ceramic brick ⁸⁾	– ¹⁾ /0,14 ²⁾ – ³⁾ /0,43 ⁴⁾	– ¹⁾ /0,11 ²⁾ – ³⁾ /0,62 ⁴⁾	– ¹⁾ /0,22 ²⁾ – ³⁾ /1,24 ⁴⁾	– ¹⁾ /0,14 ²⁾ – ³⁾ /0,43 ⁴⁾	– ¹⁾ /0,12 ²⁾ – ³⁾ /0,36 ⁴⁾	– ¹⁾ /0,18 ²⁾ – ³⁾ /0,54 ⁴⁾
	Calcium silicate hollow block ⁹⁾	– ¹⁾ /0,21 ²⁾ – ³⁾ /1,00 ⁴⁾	– ¹⁾ /0,18 ²⁾ – ³⁾ /0,19 ⁴⁾	– ¹⁾ /0,36 ²⁾ – ³⁾ /0,38 ⁴⁾	– ¹⁾ /0,21 ²⁾ – ³⁾ /1,00 ⁴⁾	– ¹⁾ /0,17 ²⁾ – ³⁾ /0,83 ⁴⁾	– ¹⁾ /0,26 ²⁾ – ³⁾ /1,25 ⁴⁾
	Hollow lightweight aggregate concrete element ¹⁰⁾	– ¹⁾ /0,09 ²⁾ – ³⁾ /0,26 ⁴⁾	– ¹⁾ /0,10 ²⁾ – ³⁾ /0,18 ⁴⁾	– ¹⁾ /0,20 ²⁾ – ³⁾ /0,36 ⁴⁾	– ¹⁾ /0,09 ²⁾ – ³⁾ /0,26 ⁴⁾	– ¹⁾ /0,08 ²⁾ – ³⁾ /0,22 ⁴⁾	– ¹⁾ /0,12 ²⁾ – ³⁾ /0,33 ⁴⁾
	Perforated ceramic brick ¹¹⁾	– ¹⁾ /0,14 ²⁾ – ³⁾ /0,26 ⁴⁾	– ¹⁾ /0,19 ²⁾ – ³⁾ /0,61 ⁴⁾	– ¹⁾ /0,38 ²⁾ – ³⁾ /1,02 ⁴⁾	– ¹⁾ /0,14 ²⁾ – ³⁾ /0,26 ⁴⁾	– ¹⁾ /0,12 ²⁾ – ³⁾ /0,22 ⁴⁾	– ¹⁾ /0,18 ²⁾ – ³⁾ /0,33 ⁴⁾
	Perforated ceramic brick ¹²⁾	– ¹⁾ /0,09 ²⁾ – ³⁾ /0,21 ⁴⁾	– ¹⁾ /0,07 ²⁾ – ³⁾ /0,26 ⁴⁾	– ¹⁾ /0,14 ²⁾ – ³⁾ /0,52 ⁴⁾	– ¹⁾ /0,09 ²⁾ – ³⁾ /0,21 ⁴⁾	– ¹⁾ /0,08 ²⁾ – ³⁾ /0,17 ⁴⁾	– ¹⁾ /0,12 ²⁾ – ³⁾ /0,26 ⁴⁾
	Hollow ceramic brick ¹³⁾	– ¹⁾ /0,17 ²⁾ – ³⁾ /0,21 ⁴⁾	– ¹⁾ /0,11 ²⁾ – ³⁾ /0,53 ⁴⁾	– ¹⁾ /0,22 ²⁾ – ³⁾ /1,06 ⁴⁾	– ¹⁾ /0,17 ²⁾ – ³⁾ /0,21 ⁴⁾	– ¹⁾ /0,17 ²⁾ – ³⁾ /0,17 ⁴⁾	– ¹⁾ /0,26 ²⁾ – ³⁾ /0,26 ⁴⁾
	Autoclaved aerated concrete AAC 2 ¹⁴⁾	– ¹⁾ /0,18 ²⁾ – ³⁾ /0,14 ⁴⁾	– ¹⁾ /0,09 ²⁾ – ³⁾ /0,12 ⁴⁾	– ¹⁾ /0,18 ²⁾ – ³⁾ /0,24 ⁴⁾	– ¹⁾ /0,18 ²⁾ – ³⁾ /0,14 ⁴⁾	– ¹⁾ /0,36 ²⁾ – ³⁾ /0,28 ⁴⁾	– ¹⁾ /0,54 ²⁾ – ³⁾ /0,42 ⁴⁾
	Autoclaved aerated concrete AAC 6 ¹⁴⁾	– ¹⁾ /0,43 ²⁾ – ³⁾ /0,32 ⁴⁾	– ¹⁾ /0,44 ²⁾ – ³⁾ /0,20 ⁴⁾	– ¹⁾ /0,88 ²⁾ – ³⁾ /0,40 ⁴⁾	– ¹⁾ /0,43 ²⁾ – ³⁾ /0,32 ⁴⁾	– ¹⁾ /0,86 ²⁾ – ³⁾ /0,64 ⁴⁾	– ¹⁾ /1,25 ²⁾ – ³⁾ /0,96 ⁴⁾

1) FF1-10 PP ($h_{nom} = 50$ mm)2) FF1-10 PA ($h_{nom} = 50$ mm)3) FF1-10 PP ($h_{nom} = 70$ mm)4) FF1-10 PA ($h_{nom} = 70$ mm)

5) According to EN 771-1

6) According to EN 771-2

7) For example perforated brick MAX according to EN 771-1; a = 12 mm, b = 38 mm, c = 8 mm

8) For example perforated brick PoroTherm P+W 25 according to EN 771-1; a = 10,2 mm, b = 38 mm, c = 7 mm

9) For example calcium silicate hollow block KSL 6DF according to DIN 106 and EN 771-2; a = 22 mm, b = 50 mm, c = 22 mm

10) For example hollow lightweight aggregate concrete element HBL according to EN 771-3; a = 31 mm

11) For example perforated brick HLZ 12 according to DIN 105 and EN 771-1; a = 12 mm, b = 32 mm, c = 7 mm, d = 12 mm, e = 13 mm

12) For example perforated brick Doppio uni according to EN 771-1; a = 11 mm, b = 24 mm, c = 10 mm

13) For example perforated brick Optibric PV according to EN 771-1; a = 10 mm, b = 39 mm, c = 7, d = 38 mm, e = 6,5 mm

14) According to EN 771-4

FF1

Performances of FF1-10 anchor
Displacements in masonry

Annex C4

of European
Technical Assessment
ETA-12/0398

Table C11: Displacements under tension and shear loading of FF1-10 anchor in autoclaved aerated concrete installation with punch-tool

Anchor type	Base material	Tension load			Shear load		
		N [kN]	δ_{N0} [mm]	$\delta_{N\infty}$ [mm]	V [kN]	δ_{V0} [mm]	$\delta_{V\infty}$ [mm]
FF1-10 PA ($h_{nom} = 70$ mm)	Autoclaved aerated concrete AAC 2 ¹⁾²⁾	0,14	0,19	0,38	0,14	0,28	0,42
	Autoclaved aerated concrete AAC 4 ¹⁾²⁾	0,43	0,29	0,58	0,43	0,86	1,29
	Autoclaved aerated concrete AAC 5 ¹⁾²⁾	0,53	0,35	0,70	0,53	1,06	1,59

¹⁾ According to EN 771-4

²⁾ Drill method: punch tool (see Annex A)

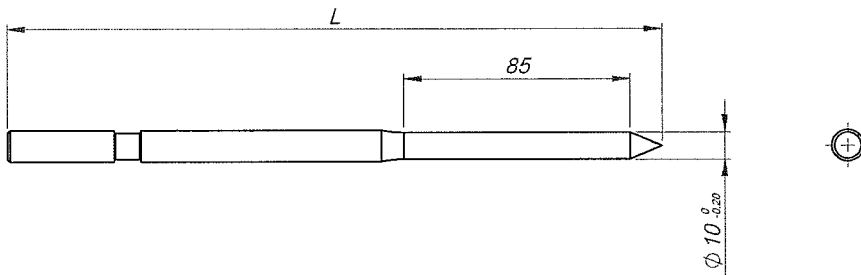

FF1	Annex C4 of European Technical Assessment ETA-12/0398
Performances of FF1-10 anchor Displacements in masonry	

Table C12: Displacements under tension and shear loading of FF1-14 anchor in masonry

Anchor type	Base material	Tension load			Shear load		
		N [kN]	δ_{N0} [mm]	$\delta_{N\infty}$ [mm]	V [kN]	δ_{V0} [mm]	$\delta_{V\infty}$ [mm]
FF1-14	Clay brick HD ³⁾	1,14 ¹⁾ 1,28 ²⁾	1,35 ¹⁾ 0,71 ²⁾	2,7 ¹⁾ 1,42 ²⁾	1,14 ¹⁾ 1,28 ²⁾	0,95 ¹⁾ 1,06 ²⁾	1,42 ¹⁾ 1,59 ²⁾
	Sand-lime brick HD ⁴⁾	0,86 ¹⁾ 1,00 ²⁾	1,28 ¹⁾ 0,79 ²⁾	2,56 ¹⁾ 1,58 ²⁾	0,86 ¹⁾ 1,00 ²⁾	0,71 ¹⁾ 0,83 ²⁾	1,06 ¹⁾ 1,25 ²⁾
	Perforated ceramic brick ⁵⁾	0,26 ¹⁾ 0,34 ²⁾	0,83 ¹⁾ 1,48 ²⁾	1,66 ¹⁾ 2,96 ²⁾	0,26 ¹⁾ 0,34 ²⁾	0,22 ¹⁾ 0,28 ²⁾	0,33 ¹⁾ 0,42 ²⁾
	Perforated ceramic brick ⁶⁾	0,26 ¹⁾ 0,34 ²⁾	0,52 ¹⁾ 1,24 ²⁾	1,04 ¹⁾ 2,48 ²⁾	0,26 ¹⁾ 0,34 ²⁾	0,22 ¹⁾ 0,28 ²⁾	0,33 ¹⁾ 0,42 ²⁾
	Calcium silicate hollow block ⁷⁾	0,26 ¹⁾ 0,34 ²⁾	0,61 ¹⁾ 0,80 ²⁾	1,22 ¹⁾ 1,60 ²⁾	0,26 ¹⁾ 0,34 ²⁾	0,22 ¹⁾ 0,28 ²⁾	0,33 ¹⁾ 0,42 ²⁾
	Hollow lightweight aggregate concrete element ⁸⁾	0,34 ¹⁾ 0,34 ²⁾	1,35 ¹⁾ 0,64 ²⁾	2,70 ¹⁾ 1,28 ²⁾	0,34 ¹⁾ 0,34 ²⁾	0,28 ¹⁾ 0,28 ²⁾	0,42 ¹⁾ 0,42 ²⁾
	Perforated ceramic brick ⁹⁾	0,43 ¹⁾ 0,26 ²⁾	0,79 ¹⁾ 0,86 ²⁾	1,58 ¹⁾ 1,72 ²⁾	0,43 ¹⁾ 0,26 ²⁾	0,36 ¹⁾ 0,22 ²⁾	0,54 ¹⁾ 0,33 ²⁾
	Perforated ceramic brick ¹⁰⁾	0,43 ¹⁾ 0,34 ²⁾	0,68 ¹⁾ 1,57 ²⁾	1,36 ¹⁾ 3,14 ²⁾	0,43 ¹⁾ 0,34 ²⁾	0,36 ¹⁾ 0,28 ²⁾	0,54 ¹⁾ 0,42 ²⁾
	Autoclaved aerated concrete AAC 2 ¹¹⁾	0,27 ¹⁾ 0,21 ²⁾	1,24 ¹⁾ 0,77 ²⁾	2,48 ¹⁾ 1,54 ²⁾	0,27 ¹⁾ 0,21 ²⁾	0,54 ¹⁾ 0,42 ²⁾	0,81 ¹⁾ 0,63 ²⁾
	Autoclaved aerated concrete AAC 6 ¹¹⁾	0,89 ¹⁾ 0,53 ²⁾	0,74 ¹⁾ 1,08 ²⁾	1,48 ¹⁾ 2,16 ²⁾	0,89 ¹⁾ 0,53 ²⁾	1,78 ¹⁾ 1,06 ²⁾	2,67 ¹⁾ 1,59 ²⁾

1) FF1-14 PP ($h_{nom} = 70$ mm)2) FF1-14 PA ($h_{nom} = 70$ mm)

3) According to EN 771-1

4) According to EN 771-2

5) For example perforated brick MAX according to EN 771-1; a = 12 mm, b = 38 mm, c = 8 mm

6) Perforated brick PoroTherm P+W 25 according to EN 771-1; a = 10,2 mm, b = 38 mm, c = 7 mm

7) For example calcium silicate hollow block KSL 6DF according to DIN 106 and EN 771-2; a = 22 mm, b = 50 mm, c = 22 mm

8) For example hollow lightweight aggregate concrete element HBL according to EN 771-3; a = 31 mm

9) For example perforated brick HLZ 12 according to DIN 105 and EN 771-1; a = 12 mm, b = 32 mm, c = 7 mm, d = 12 mm, e = 13 mm

10) For example perforated brick HLZ 15 according to DIN 105 and EN 771-1; a = 17 mm

11) According to EN 771-4

FF1

Performances of FF1-14 anchor
Displacements in masonry

Annex C4
of European
Technical Assessment
ETA-12/0398